

CONNECTOR
DESIGNATORS
A-F-H-L-S
SELF-LOCKING
ROTATABLE
COUPLING

TYPE E INDIVIDUAL
AND/OR OVERALL
SHIELD TERMINATION

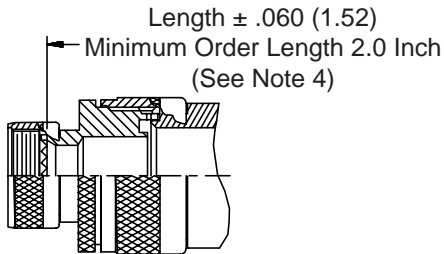

STYLE 2
(STRAIGHT
See Note 1)

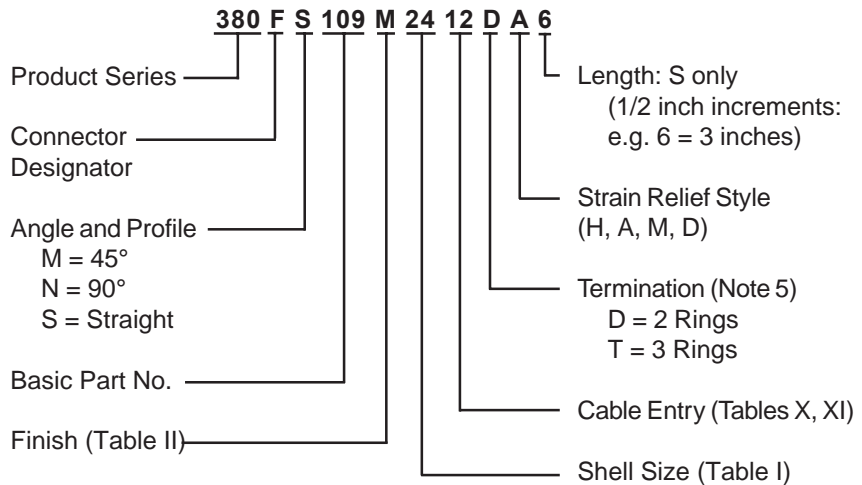
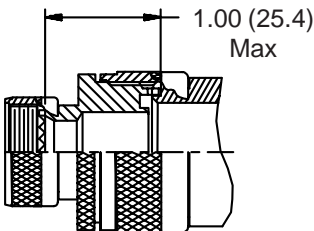
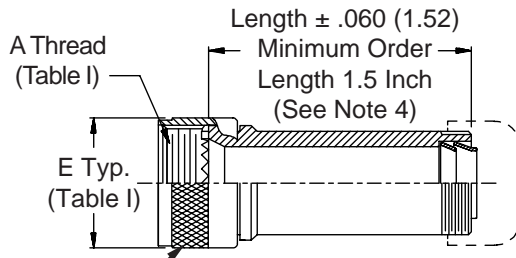

STYLE 2
(45° & 90°
See Note 1)

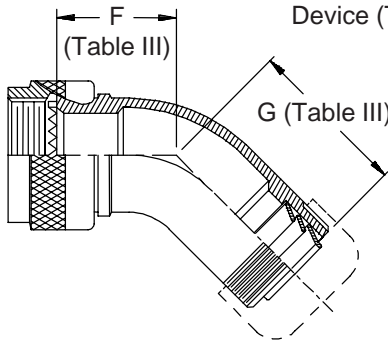

Anti-Rotation Device (Typ.)

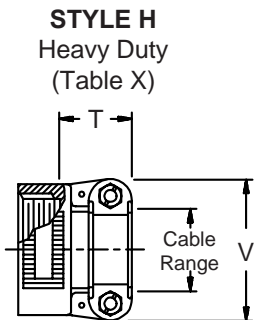
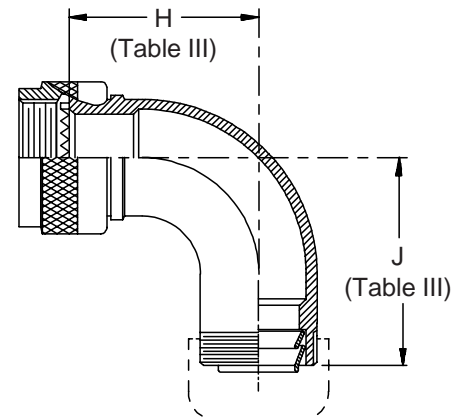

STYLE H
Heavy Duty
(Table X)

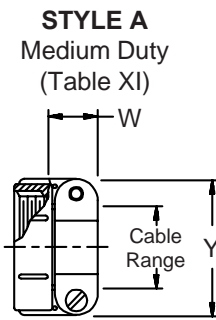

STYLE A
Medium Duty
(Table XI)

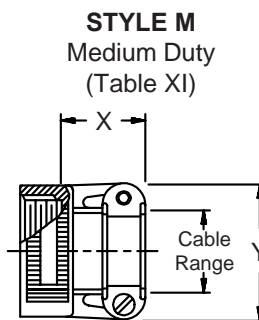

STYLE M
Medium Duty
(Table XI)

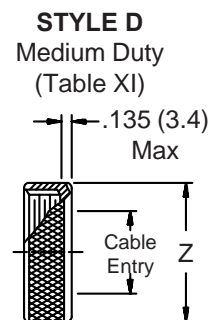

STYLE D
Medium Duty
(Table XI)

