

**CONNECTOR
 DESIGNATORS
 A-F-H-L-S
 SELF-LOCKING
 ROTATABLE
 COUPLING**

**TYPE E INDIVIDUAL
 AND/OR OVERALL
 SHIELD TERMINATION**

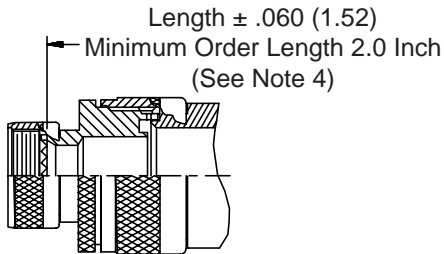

**STYLE 2
 (STRAIGHT
 See Note 1)**

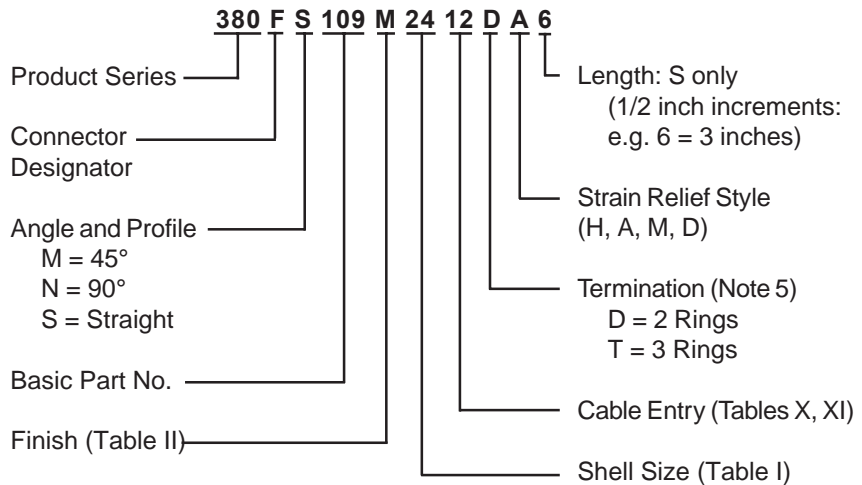
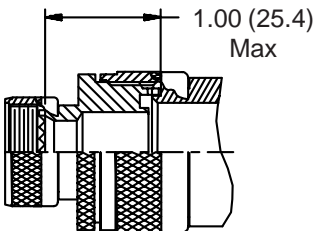

**STYLE 2
 (45° & 90°
 See Note 1)**

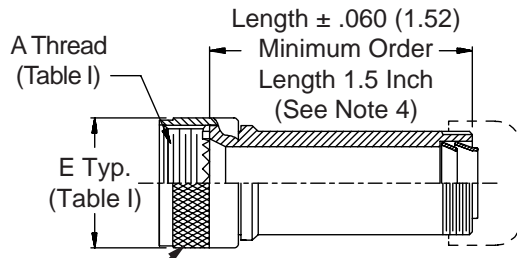

Anti-Rotation Device (Typ.)

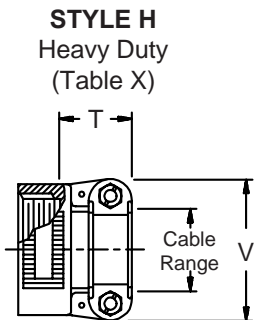
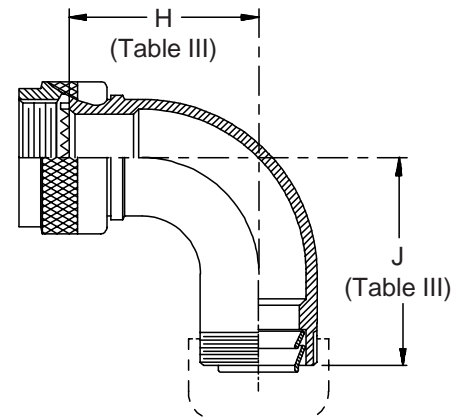
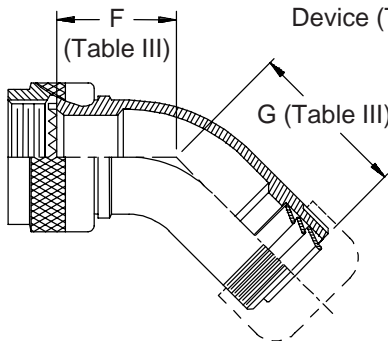

**STYLE H
 Heavy Duty
 (Table X)**

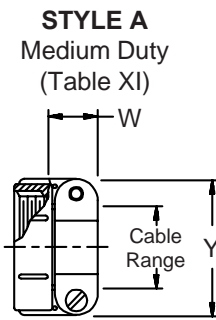

**STYLE A
 Medium Duty
 (Table XI)**

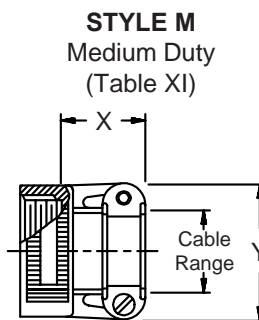

**STYLE M
 Medium Duty
 (Table XI)**

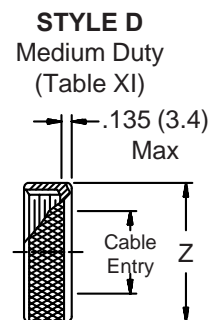

**STYLE D
 Medium Duty
 (Table XI)**

