

**CONNECTOR
 DESIGNATORS**
A-B*-C-D-E-F
G-H-J-K-L-S

* Conn. Desig. B See Note 5
DIRECT COUPLING

**TYPE C OVERALL
 SHIELD TERMINATION**

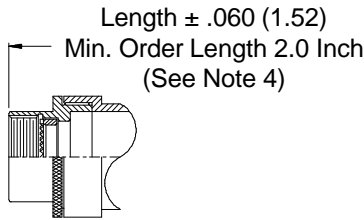
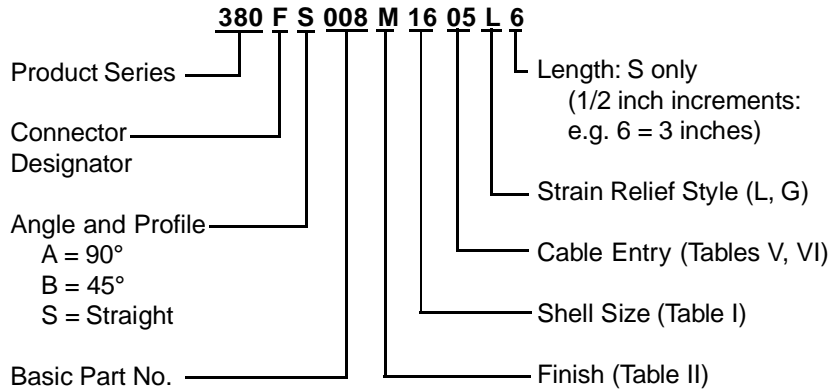

STYLE 2
(STRAIGHT)
 See Note 1)

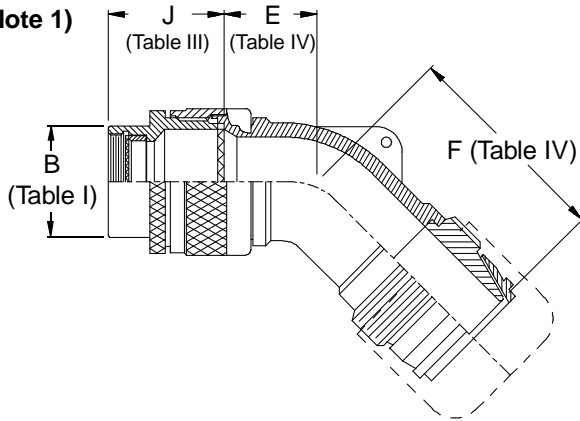
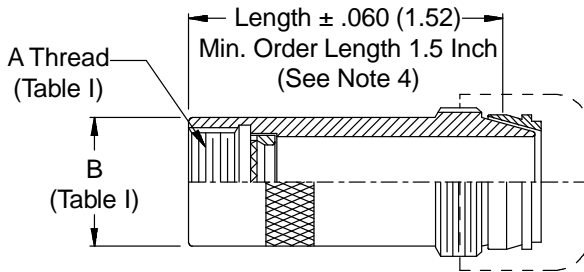

STYLE L
 Light Duty
 (Table V)

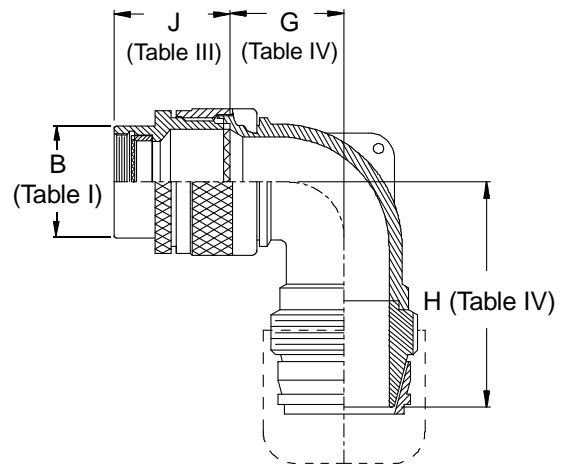
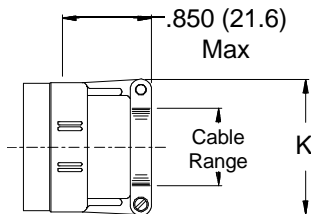

STYLE G
 Light Duty
 (Table VI)

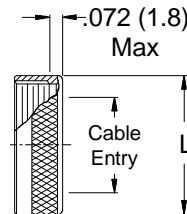

380-008
EMI/RFI Non-Environmental Backshell
Light-Duty with Strain Relief
Type C - Direct Coupling - Low Profile



TABLE III: FRONT ADAPTER

Shell Size	J Max - Conn. Designator		
	A-E-F		
	J-H-L-S	D-B-G-K	C
08/09	1.180 (30.0)	1.250 (31.8)	
10/11	1.180 (30.0)	1.250 (31.8)	
12/13	1.180 (30.0)	1.250 (31.8)	1.735 (44.1)
14/15	1.180 (30.0)	1.250 (31.8)	1.915 (48.6)
16/17	1.380 (35.0)	1.560 (39.6)	1.915 (48.6)
18/19	1.380 (35.0)	1.560 (39.6)	1.915 (48.6)
20/21	1.380 (35.0)	1.560 (39.6)	1.915 (48.6)
22/23	1.380 (35.0)	1.560 (39.6)	1.915 (48.6)
24/25	1.380 (35.0)	1.560 (39.6)	1.915 (48.6)
28/29	1.610 (40.9)	1.560 (39.6)	1.915 (48.6)
32/33	1.610 (40.9)	1.750 (44.5)	1.915 (48.6)
36	1.610 (40.9)	1.750 (44.5)	1.915 (48.6)
40	1.610 (40.9)	2.190 (55.6)	1.915 (48.6)

See inside back cover fold-out or pages 13 and 14 for unabridged Tables I and II.

1. When maximum cable entry (page 22) is exceeded, Style 2 will be supplied. (Function S only).
2. Metric dimensions (mm) are indicated in parentheses.
3. Cable range is defined as the accommodations range for the wire bundle or cable. Dimensions shown are not intended for inspection criteria.
4. Consult factory for shorter lengths on straight backshells.
5. When using Connector Designator B refer to pages 18 and 19 for part number development.

TABLE IV: ELBOW DIMENSIONS

Elbow Size	E Max	F Max	G Max	H Max
01	.457 (11.6)	1.680 (42.7)	.636 (16.2)	1.781 (45.2)
02	.457 (11.6)	1.680 (42.7)	.636 (16.2)	1.781 (45.2)
03	.520 (13.2)	1.740 (44.2)	.709 (18.0)	1.901 (48.3)
04	.582 (14.8)	1.800 (45.7)	.734 (18.6)	1.921 (48.8)
05	.738 (18.7)	2.000 (50.8)	.825 (21.0)	1.991 (50.6)
06	.926 (23.5)	2.190 (55.6)	.990 (25.1)	2.081 (52.9)
07	.926 (23.5)	2.190 (55.6)	1.090 (27.7)	2.251 (57.2)
08	1.020 (25.9)	2.340 (59.4)	1.325 (33.7)	2.361 (60.0)
09	1.020 (25.9)	2.340 (59.4)	1.325 (33.7)	2.361 (60.0)
10	1.145 (29.1)	2.390 (60.7)	1.325 (33.7)	2.361 (60.0)

TABLE II: STANDARD FINISHES

GLENAIR SYMBOL	FINISH
B	Cadmium Plate, Olive Drab
M	Electroless Nickel
NF	Cadmium Plate, Olive Drab Over Electroless Nickel

See Inside Back Cover for Additional Finish Options

TABLE V: CABLE ENTRY

Dash No.	K Max	Cable Range	
		Min	Max
01	.781 (19.8)	.062 (1.6)	.125 (3.2)
02	.968 (24.6)	.125 (3.2)	.250 (6.4)
03	1.046 (26.6)	.250 (6.4)	.375 (9.5)
04	1.156 (29.4)	.250 (6.4)	.500 (12.7)
05	1.218 (30.9)	.375 (9.5)	.625 (15.9)
06	1.343 (34.1)	.500 (12.7)	.750 (19.1)
07	1.468 (37.3)	.625 (15.9)	.875 (22.2)
08	1.593 (40.5)	.625 (15.9)	1.000 (25.4)
09	1.718 (43.6)	.750 (19.1)	1.125 (28.6)
10	1.843 (46.8)	.875 (22.2)	1.250 (31.8)

TABLE VI: CABLE ENTRY

Dash No.	L Max	Cable Entry Max
01	.593 (15.1)	.125 (3.2)
02	.718 (18.2)	.250 (6.4)
03	.843 (21.4)	.375 (9.5)
04	.968 (24.6)	.500 (12.7)
05	1.109 (28.2)	.625 (15.9)
06	1.218 (30.9)	.750 (19.1)
07	1.343 (34.1)	.875 (22.2)
08	1.468 (37.3)	1.000 (25.4)
09	1.593 (40.5)	1.125 (28.6)
10	1.718 (43.6)	1.250 (31.8)