

380-019
EMI/RFI Non-Environmental Backshell
with Strain Relief
Type E - Direct Coupling - Low Profile

CONNECTOR DESIGNATORS
A-B*-C-D-E-F
G-H-J-K-L-S
 * Conn. Desig. B See Note 5
DIRECT COUPLING

TYPE E INDIVIDUAL AND/OR OVERALL SHIELD TERMINATION

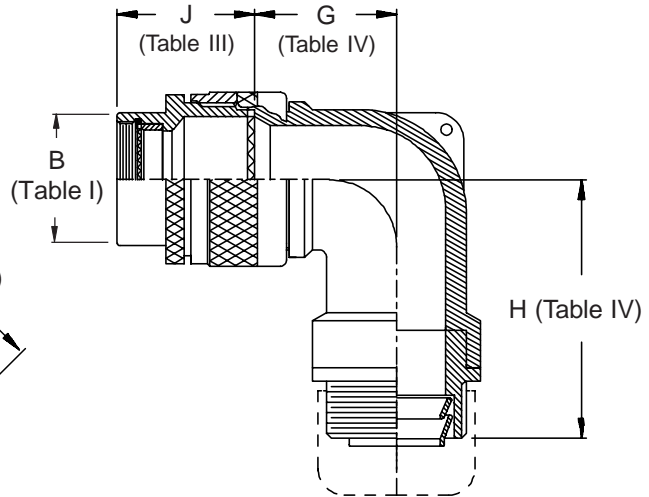
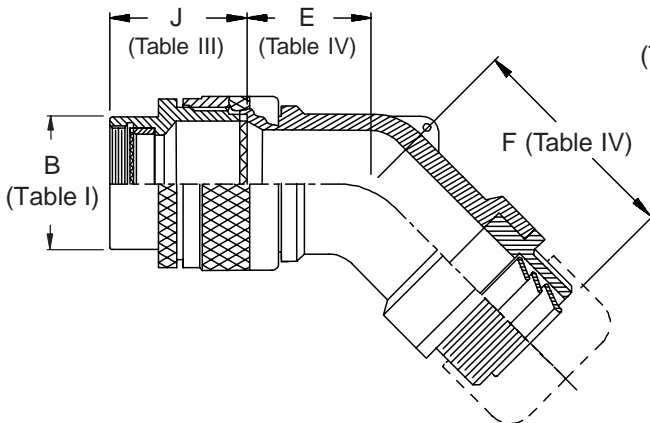
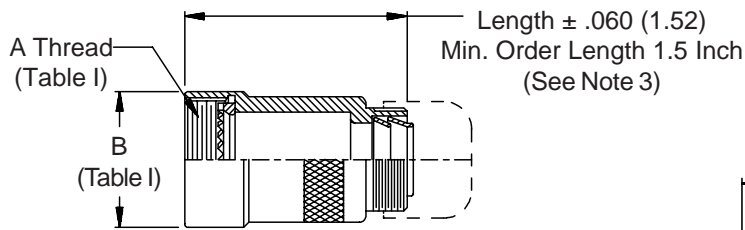
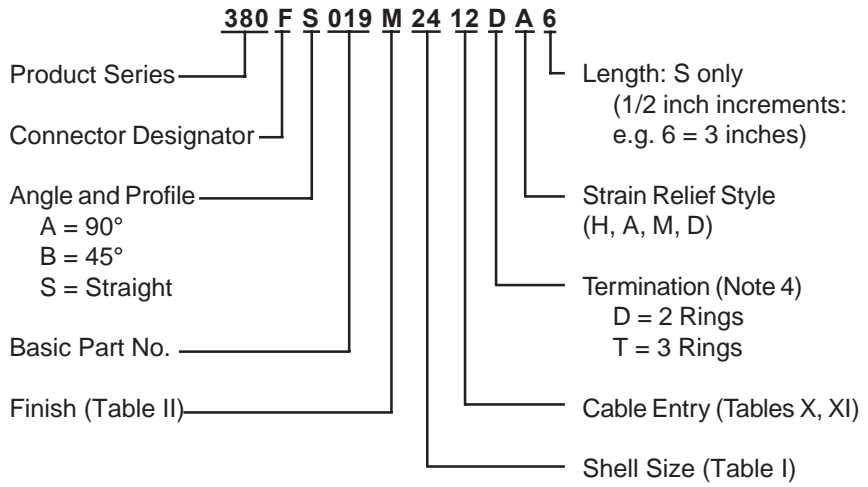

STYLE H
 Heavy Duty
 (Table X)

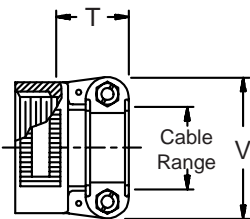

STYLE A
 Medium Duty
 (Table XI)

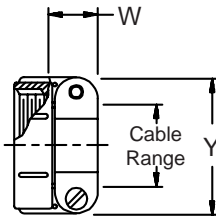

STYLE M
 Medium Duty
 (Table XI)

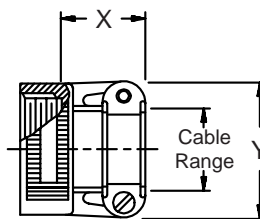

STYLE D
 Medium Duty
 (Table XI)

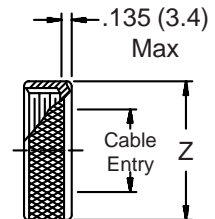

380-019
EMI/RFI Non-Environmental Backshell
 with Strain Relief
 Type E - Direct Coupling - Low Profile



See inside back cover fold-out or pages 13 and 14 for unabridged Tables I and II.

TABLE III: FRONT ADAPTER			
Shell Size	J Max - Conn. Designator		
	A-E-F		C
	J-H-L-S	D-B-G-K	
08/09	1.180 (30.0)	1.250 (31.8)	
10/11	1.180 (30.0)	1.250 (31.8)	
12/13	1.180 (30.0)	1.250 (31.8)	1.735 (44.1)
14/15	1.180 (30.0)	1.250 (31.8)	1.915 (48.6)
16/17	1.380 (35.0)	1.560 (39.6)	1.915 (48.6)
18/19	1.380 (35.0)	1.560 (39.6)	1.915 (48.6)
20/21	1.380 (35.0)	1.560 (39.6)	1.915 (48.6)
22/23	1.380 (35.0)	1.560 (39.6)	1.915 (48.6)
24/25	1.380 (35.0)	1.560 (39.6)	1.915 (48.6)
28/29	1.610 (40.9)	1.560 (39.6)	1.915 (48.6)
32/33	1.610 (40.9)	1.750 (44.5)	1.915 (48.6)
36	1.610 (40.9)	1.750 (44.5)	1.915 (48.6)
40	1.610 (40.9)	2.190 (55.6)	1.915 (48.6)

TABLE IV: ELBOW DIMENSIONS					
Elbow Size	E Max	F Max	G Max	H Max	
03	.457 (11.6)	1.470 (37.3)	.500 (12.7)	1.480 (37.6)	
04	.457 (11.6)	1.470 (37.3)	.500 (12.7)	1.480 (37.6)	
06	.520 (13.2)	1.530 (38.9)	.595 (15.1)	1.600 (40.6)	
08	.582 (14.8)	1.590 (40.4)	.610 (15.5)	1.620 (41.1)	
10	.645 (16.4)	1.680 (42.7)	.700 (17.8)	1.690 (42.9)	
12	.738 (18.7)	1.790 (45.5)	.885 (22.5)	1.950 (49.5)	
16	.926 (23.5)	1.980 (50.3)	.975 (24.8)	2.060 (52.3)	
20	1.020 (25.9)	2.130 (54.1)	1.125 (28.6)	2.060 (52.3)	

1. Metric dimensions (mm) are indicated in parentheses.
2. Cable range is defined as the accommodations range for the wire bundle or cable. Dimensions shown are not for inspection criteria.
3. Consult factory for shorter lengths on straight backshells.
4. Designate Symbol T for 3 ring termination of individual and overall braid. Designate D for standard 2 ring termination of individual or overall braid.
5. When using Connector Designator B refer to pages 18 and 19 for part number development.

TABLE X: CABLE ENTRY					
Dash No.	T Max	V Max	Cable Range		
			Min	Max	
04	.780 (19.8)	.957 (24.3)	.125 (3.2)	.312 (7.9)	
06	.780 (19.8)	1.145 (29.1)	.250 (6.4)	.437 (11.1)	
08	.780 (19.8)	1.332 (33.8)	.312 (7.9)	.562 (14.3)	
10	.780 (19.8)	1.332 (33.8)	.350 (8.9)	.625 (15.9)	
12	.811 (20.6)	1.551 (39.4)	.500 (12.7)	.750 (19.1)	
16	.905 (23.0)	1.770 (45.0)	.625 (15.9)	.937 (23.8)	
20	1.092 (27.7)	2.113 (53.7)	.875 (22.2)	1.250 (31.8)	
24	1.124 (28.5)	2.363 (60.0)	1.000 (25.4)	1.375 (34.9)	
28	1.399 (35.5)	2.770 (70.4)	1.250 (31.8)	1.625 (41.3)	
32	1.399 (35.5)	3.020 (76.7)	1.437 (36.5)	1.875 (47.6)	

TABLE II: STANDARD FINISHES	
GLENAIR SYMBOL	FINISH
B	Cadmium Plate, Olive Drab
M	Electroless Nickel
NF	Cadmium Plate, Olive Drab Over Electroless Nickel
See Inside Back Cover for Additional Finish Options	

TABLE XI: CABLE ENTRY							
Dash No.	W Max	X Max	Y Max	Z Max	Cable Range		
					Min **	Max	
03*	.437 (11.1)	.760 (19.3)	.843 (21.4)	.630 (16.0)	.156 (4.0)	.250 (6.4)	
04*	.437 (11.1)	.760 (19.3)	.906 (23.0)	.755 (19.2)	.188 (4.8)	.312 (7.9)	
06*	.500 (12.7)	.760 (19.3)	1.093 (27.8)	.942 (23.9)	.281 (7.1)	.438 (11.1)	
08	.563 (14.3)	.760 (19.3)	1.187 (30.1)	1.067 (27.1)	.344 (8.7)	.562 (14.3)	
10	.563 (14.3)	.760 (19.3)	1.281 (32.5)	1.192 (30.3)	.375 (9.5)	.625 (15.9)	
12	.563 (14.3)	.760 (19.3)	1.500 (38.1)	1.380 (35.1)	.438 (11.1)	.750 (19.1)	
16	.656 (16.7)	1.073 (27.3)	1.719 (43.7)	1.535 (39.0)	.562 (14.3)	.938 (23.8)	
20	.656 (16.7)	1.323 (33.6)	2.062 (52.4)	1.848 (46.9)	.750 (19.1)	1.250 (31.8)	
24	.656 (16.7)	1.323 (33.6)	2.312 (58.7)	2.255 (57.3)	.781 (19.8)	1.375 (34.9)	
28	1.188 (30.2)	1.572 (39.9)	2.719 (69.1)	2.505 (63.6)	.969 (24.6)	1.625 (41.3)	
32*	1.187 (30.1)	1.572 (39.9)	2.969 (75.4)	2.755 (70.0)	1.125 (28.6)	1.875 (47.6)	
40*	1.125 (28.6)	1.572 (39.9)	3.531 (89.7)	3.255 (82.7)	1.469 (37.3)	2.375 (60.3)	

* Not available in Style M clamp.

** Not Applicable Style D