

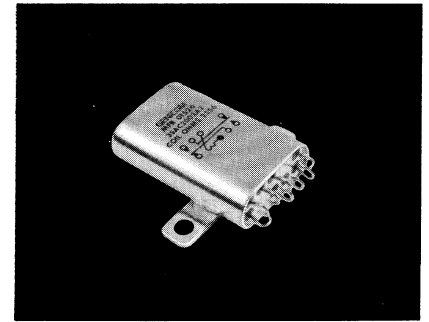

Code Location Guide

# Crystal-can Micro-miniature Relays



A

## Type 3SAE (2PDT) Type 3SAC (2PDT)

### Features

- Small lightweight crystal can type
- 0.25 cubic inch, 0.60 ounces
- Power or low-level switching
- 20G to 2000 Hz vibration capability

### Description

CIIT's line of micro-miniature crystal can relays is backed by years of experience and millions of relays operating in the field.

### Other Specifications

#### Contact Ratings:

DC resistive — 2 amps at 28 volts  
DC inductive — 1 amp at 28 volts,  
L/R < .025

Low-level — 50  $\mu$ A at 50 mV  
Peak AC or DC  
AC resistive — 1.0 amp at 115 volts,  
case not grounded  
AC resistive — 0.25 amps at 115 volts,  
case grounded

#### Contact Resistance:

0.050 ohms max. initial  
0.100 ohms max. after life test

#### Life:

100,000 operations at rated load  
1,000,000 at low-level

#### Operate Time:

6 ms max.

#### Release Time:

5 ms max.

#### Bounce:

2.5 ms

#### Dielectric Strength:

1,000 VRMS at sea level;  
700 VRMS across contact gaps;  
350 VRMS at 70,000 feet

#### Insulation Resistance:

1,000 megohms minimum except coil  
to case 500 minimum at 125C

#### Vibration:

Depends upon mounting forms

#### Shock:

50G at 11 ms

#### Temperature:

-65C to +125C

See page 39 for Mounting Forms,  
Terminals and Circuit Diagrams.

F

Coil Table (All Values DC)\*  
Type 3SAE 330 mW Sensitivity: (Code 1)

Coil Code Letter	Voltage Calibrated, CODE: 5				
	Coil Resistance at 25C (Ohms)	Suggested Source Volts†	Maximum Operate Volts at 25C	Release Voltage at 25C	
				Max	Min
A	22 $\pm$ 10%	3.9- 5.9	2.7	1.4	0.29
B	34 $\pm$ 10%	4.8- 7.4	3.3	1.7	0.36
C	53 $\pm$ 10%	6.2- 9.2	4.2	2.2	0.46
D	92 $\pm$ 10%	8.0-12.0	5.4	2.8	0.60
E	146 $\pm$ 10%	10.2-15.0	6.9	3.6	0.76
F	215 $\pm$ 10%	12.3-18.5	8.3	4.3	0.92
H	342 $\pm$ 10%	15.4-23.0	10.4	5.4	1.16
K	552 $\pm$ 10%	20.0-29.5	13.5	7.0	1.50
L	814 $\pm$ 10%	25.0-36.0	16.9	8.8	1.88
M	1180 $\pm$ 10%	30.0-43.0	20.5	10.6	2.28
N	1278 $\pm$ 15%	31.0-41.5	21.3	11.0	2.36
P	1800 $\pm$ 15%	38.0-49.0	25.8	13.3	2.86
R	2530 $\pm$ 15%	43.0-58.5	29.0	15.0	3.22
S	2950 $\pm$ 15%	50.0-63.0	34.0	17.5	3.77
T	5000 $\pm$ 20%	62.0-75.0	41.8	21.6	4.64
V	5170 $\pm$ 20%	68.0-76.0	46.0	25.4	5.12

Coil Table (All Values DC)\*  
Type 3SAC 200 mW Sensitivity: (Code 2)

Coil Code Letter	Current Calibrated, CODE: 6				
	Coil Resistance at 25C (Ohms)	Maximum Operate Current at 25C (mA)	Maximum Continuous Current at 125C (mA)	Release Current at 25C (mA)	
				Max	Min
A	184 $\pm$ 10%	32.0	65.0	16.5	3.53
B	292 $\pm$ 10%	25.6	51.5	13.3	2.84
C	430 $\pm$ 10%	20.8	42.5	10.8	2.31
D	684 $\pm$ 10%	16.4	33.5	8.5	1.80
E	1104 $\pm$ 10%	13.2	26.5	6.9	1.46
F	1628 $\pm$ 10%	11.2	21.7	5.8	1.24
H	2360 $\pm$ 15%	9.4	16.8	4.9	1.04
K	2556 $\pm$ 15%	9.0	16.2	4.7	0.99
L	3600 $\pm$ 15%	7.7	13.5	4.1	0.86
M	5060 $\pm$ 15%	6.2	11.5	3.3	0.69
N	5900 $\pm$ 15%	6.2	10.5	3.3	0.71
P	10000 $\pm$ 20%	4.5	7.5	2.4	0.50
R	10340 $\pm$ 20%	4.8	7.4	2.5	0.54

\* Values listed are factory test and inspection values. User should allow for meter variations.

† Applicable over the operating temperature range in circulating air.

## ORDERING INSTRUCTIONS

**Example:** The relay selected in this example is a 2PDT crystal can relay, voltage calibrated, two-hole side bracket mount-

ing, solder hook header, 552 ohms coil resistance, and 330 mW sensitivity. By choosing the proper code for each of these relay characteristics, the catalog number is identified as 3SAE5041K1. The letter R following sensitivity code indicates relay received 5000 operations miss-test. Ex. 3SAE5041K1R.

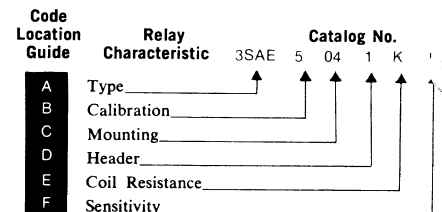

# Mounting Forms (3SAC, 3SAE)

(Vibration note with each form is acceleration from 55 to 2000 Hz)

All dimensions in inches

TOLERANCES (unless otherwise specified)	
Hundredths	±0.020
Thousandths	±0.005

Code Location Guide

### No Mount

Mounting Code	A Dim. (Max)	Vibration*	Relay Type
00	0.875	20g	3SAE
00	1.187	15g	3SAC

\* Assumes relay securely held by potting or other means.

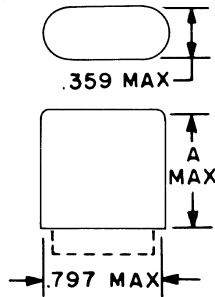

### Flange Mount, 2 in-line holes

Mounting Code	A Dim. (Max)	X Dim.	Vibration	Relay Type
13	0.875	0.125	15g	3SAE
13	1.187	0.125	10g	3SAC
14	0.875	0.375	20g	3SAE
14	1.187	0.455	15g	3SAC

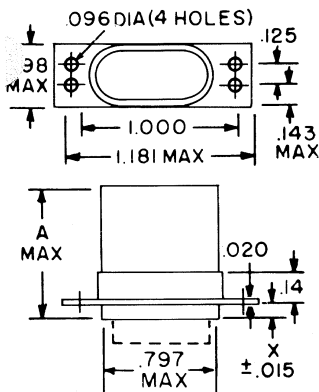
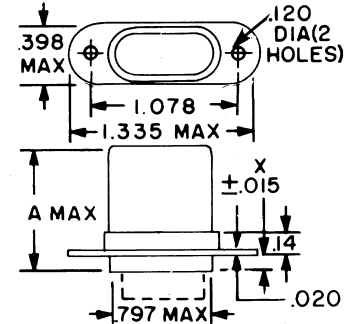

### Four-hole Flange

Mounting Code	A Dim. (Max)	X Dim.	Vibration	Relay Type
01	0.875	0.125	15g	3SAE
01	1.187	0.125	10g	3SAC
02	0.875	0.375	20g	3SAE
02	1.187	0.455	15g	3SAC

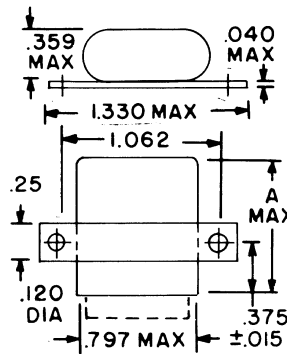

### Two-hole Side Bracket

Mounting Code	A Dim. (Max)	Vibration	Relay Type
04	0.875	20g	3SAE
04	1.187	15g	3SAC

### Side Studs

Mounting Code	A Dim. (Max)	C Dim.	X Dim.	Vibration	Relay Type
07	0.875	0.488	0.375	20g	3SAE
07	1.187	0.800	0.375	15g	3SAC
08	0.875	0.488	0.250	20g	3SAE
08	1.187	0.800	0.250	15g	3SAC

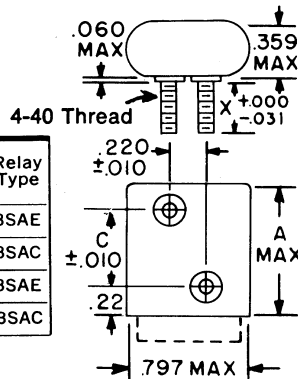

### Top Studs

Mounting Code	A Dim. (Max)	X Dim.	Vibration	Relay Type
10	0.940	0.375	20g	3SAE
10	1.252	0.375	15g	3SAC
11	0.940	0.250	20g	3SAE
11	1.252	0.250	15g	3SAC

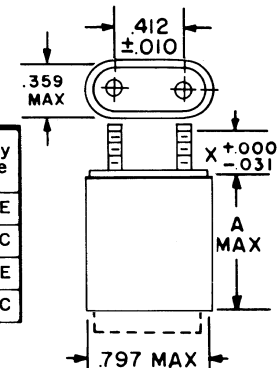

## Header and Connection Diagrams

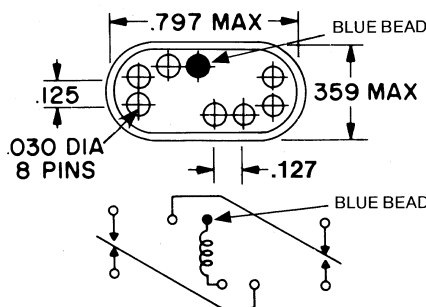

## Header Types

Type	Z Dim.	Header Code
Solder hook	0.19	3
Straight pin (socket or PCB type)	0.19	4
Straight pin	2.99	8

CODE: 3

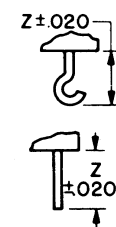

CODES: 4, 8

C

D