

Thin-Film Technology

THE IDEAL CAPACITOR

The non-ideal characteristics of a real capacitor can be ignored at low frequencies. Physical size imparts inductance to the capacitor and dielectric and metal electrodes result in resistive losses, but these often are of negligible effect on the circuit. At the very high frequencies of radio communication (>100MHz) and satellite systems (>1GHz), these effects become important. Recognizing that a real capacitor will exhibit inductive and resistive impedances in addition to capacitance, the ideal capacitor for these high frequencies is an ultra low loss component which can be fully characterized in all parameters with total repeatability from unit to unit.

Until recently, most high frequency/microwave capacitors were based on fired-ceramic (porcelain) technology. Layers of ceramic dielectric material and metal alloy electrode paste are interleaved and then sintered in a high temperature oven. This technology exhibits component variability in dielectric quality (losses, dielectric constant and insulation resistance), variability in electrode conductivity and variability in physical size (affecting inductance). An alternate thin-film technology has been developed which virtually eliminates these variances. It is this technology which has been fully incorporated into Accu-F® and Accu-P® to provide high frequency capacitors exhibiting truly ideal characteristics.

The main features of Accu-F® and Accu-P® may be summarized as follows:

- High purity of electrodes for very low and repeatable ESR.
- Highly pure, low-K dielectric for high breakdown field, high insulation resistance and low losses to frequencies above 40GHz.
- Very tight dimensional control for uniform inductance, unit to unit.
- Very tight capacitance tolerances for high frequency signal applications.

This accuracy sets apart these Thin-Film capacitors from ceramic capacitors so that the term Accu has been employed as the designation for this series of devices, an abbreviation for “accurate.”

THIN-FILM TECHNOLOGY

Thin-film technology is commonly used in producing semiconductor devices. In the last two decades, this technology has developed tremendously, both in performance and in process control. Today’s techniques enable line definitions of below 1µm, and the controlling of thickness of layers at 100Å (10⁻²µm). Applying this technology to the manufacture of capacitors has enabled the development of components where both electrical and physical properties can be tightly controlled.

The thin-film production facilities at AVX consist of:

- Class 1000 clean rooms, with working areas under laminar-flow hoods of class 100, (below 100 particles per cubic foot larger than 0.5µm).
- High vacuum metal deposition systems for high-purity electrode construction.
- Photolithography equipment for line definition down to 2.0µm accuracy.
- Plasma-enhanced CVD for various dielectric depositions (CVD=Chemical Vapor Deposition).
- High accuracy, microprocessor-controlled dicing saws for chip separation.
- High speed, high accuracy sorting to ensure strict tolerance adherence.

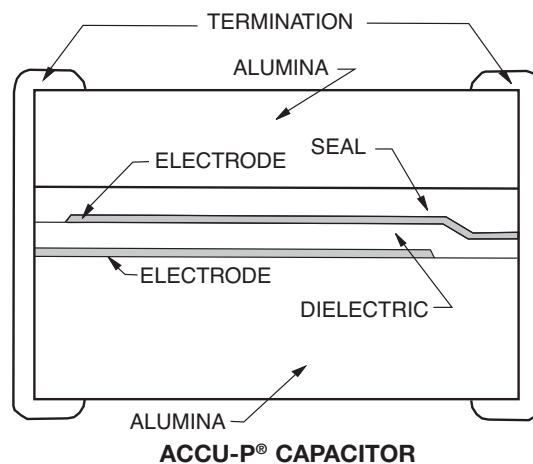

Thin-Film Chip Capacitors

ACCU-F® TECHNOLOGY

The use of very low-loss dielectric materials, silicon dioxide and silicon oxynitride, in conjunction with highly conductive electrode metals results in low ESR and high Q. These high-frequency characteristics change at a slower rate with increasing frequency than for ceramic microwave capacitors.

Because of the thin-film technology, the above-mentioned frequency characteristics are obtained without significant compromise of properties required for surface mounting.

The main Accu-F® properties are:

- Internationally agreed sizes with excellent dimensional control.
- Small size chip capacitors (0603) are available.
- Tight capacitance tolerances.
- Low ESR at VHF, UHF and microwave frequencies.
- High stability with respect to time, temperature, frequency and voltage variation.
- Nickel/solder-coated terminations to provide excellent solderability and leach resistance.

ACCU-F® FEATURES

Accu-F® meets the fast-growing demand for low-loss (high-Q) capacitors for use in surface mount technology especially for the mobile communications market, such as cellular radio of 450 and 900 MHz, UHF walkie-talkies, UHF cordless telephones to 2.3 GHz, low noise blocks at 11-12.5 GHz and for other VHF, UHF and microwave applications.

Accu-F® is currently unique in its ability to offer very low capacitance values (0.1pF) and very tight capacitance tolerances ($\pm 0.05\text{pF}$). Typically Accu-F® will be used in small signal applications in VCO's, matching networks, filters, etc.

Inspection test and quality control procedures in accordance with ISO 9001, CECC, IECQ and USA MIL Standards yield products of the highest quality.

APPLICATIONS

Cellular Communications
CT2/PCN (Cordless Telephone/Personal Comm. Networks)
Satellite TV
Cable TV
GPS (Global Positioning Systems)
Vehicle Location Systems
Vehicle Alarm Systems
Paging
Military Communications

Radar Systems
Video Switching
Test & Measurements
Filters
VCO's
Matching Networks

APPROVALS

ISO 9001

ACCU-P® TECHNOLOGY

As in the Accu-F® series the use of very low-loss dielectric materials (silicon dioxide and silicon oxynitride) in conjunction with highly conductive electrode metals results in low ESR and high Q. At high frequency these characteristics change at a slower rate with increasing frequency than conventional ceramic microwave capacitors. Using thin-film technology, the above-mentioned frequency characteristics are obtained without significant compromise of properties required for surface mounting. The use of high thermal conductivity materials results in excellent RF power handling capabilities.

The main Accu-P® properties are:

- Enhanced RF power handling capability.
- Improved mechanical characteristics.
- Internationally agreed sizes with excellent dimensional control.
- Ultra Small size chip capacitors (0201) are available.
- Tight capacitance tolerances.
- Low ESR at UHF, VHF, and microwave frequencies.
- High-stability with respect to time, temperature, frequency and voltage variation.
- High temperature nickel/solder-coated terminations as standard to provide excellent solderability and leach resistance.

ACCU-P® FEATURES

- Minimal batch to batch variability of parameters at high frequency.
- The Accu-P® has the same unique features as the Accu-F® capacitor such as low ESR, high Q, availability of very low capacitance values and very tight capacitance tolerances.
- The RF power handling capability of the Accu-P® allows for its usage in both small signal and RF power applications.
- Inspection, test and quality control procedures in accordance with ISO 9001, CECC, IECQ and USA MIL Standards guarantee product of the highest quality.
- Hand soldering Accu-P®: Due to their construction utilizing relatively high thermal conductivity materials, Accu-P's have become the preferred device in R & D labs and production environments where hand soldering is used. Accu-P's are available in all sizes and are electrically identical to their Accu-F counterparts.

APPLICATIONS

Cellular Communications
CT2/PCN (Cordless Telephone/Personal Comm. Networks)
Satellite TV
Cable TV
GPS (Global Positioning Systems)
Vehicle Location Systems
Vehicle Alarm Systems
Paging
Military Communications

Radar Systems
Video Switching
Test & Measurements
Filters
VCO's
Matching Networks
RF Amplifiers

APPROVALS

ISO 9001



Accu-F® */ Accu-P®

Thin-Film Chip Capacitors for RF Signal and Power Applications



1

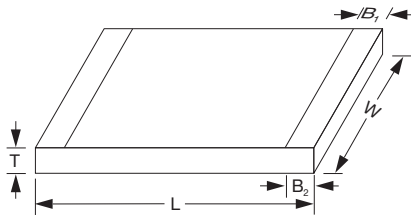

ACCU-F® *(Signal Type Capacitors)

| | 0603 | 0805 |
|----------|---------------------------|---------------------------|
| L | 1.60±0.1 (0.063±0.004) | 2.01±0.1 (0.079±0.004) |
| W | 0.81±0.1 (0.032±0.004) | 1.27±0.1 (0.050±0.004) |
| T | 0.63±0.1 (0.025±0.004) | 0.63±0.1 (0.025±0.004) |
| B | 0.30±0.1 (0.012±0.004) | 0.30±0.1 (0.012±0.004) |

*Not recommended for new designs. Accu-P's are recommended. **DIMENSIONS: millimeters (inches)**

ACCU-P® (Signal and Power Type Capacitors)

| | 0201 | 0402* | 0603* | 0805* | 1210 |
|----------------------|-------------------------------|--|----------------------------|---------------------------|---------------------------|
| L | 0.60±0.05 (0.023±0.002) | 1.00±0.1 (0.039±0.004) | 1.60±0.1 (0.063±0.004) | 2.01±0.1 (0.079±0.004) | 3.02±0.1 (0.119±0.004) |
| W | 0.325±0.050 (0.0128±0.002) | 0.55±0.07 (0.022±0.003) | 0.81±0.1 (0.032±0.004) | 1.27±0.1 (0.050±0.004) | 2.5±0.1 (0.100±0.004) |
| T | 0.225±0.050 (0.009±0.002) | 0.40±0.1 (0.016±0.004) | 0.63±0.1 (0.025±0.004) | 0.93±0.2 (0.036±0.008) | 0.93±0.2 (0.036±0.008) |
| B₁ | 0.10±0.10 (0.004±0.004) | 0.00 ^{+0.1} _{-0.0} (0.000 ^{+0.004} _{-0.000}) | 0.35±0.15 (0.014±0.006) | 0.30±0.1 (0.012±0.004) | 0.43±0.1 (0.017±0.004) |
| B₂ | 0.15±0.05 (0.006±0.002) | 0.20±0.1 (0.008±0.004) | 0.35±0.15 (0.014±0.006) | 0.30±0.1 (0.012±0.004) | 0.43±0.1 (0.017±0.004) |

*Mount Black Side Up

DIMENSIONS: millimeters (inches)

HOW TO ORDER

| 0402 | 3 | J | 4R7 | A | B | S | TR |
|---------------|----------|-----------------------------|---|-------------------------------|------------------------|---|------------------|
| Size | 1 = 100V | Temperature Coefficient (1) | Capacitance | Tolerance for C≤2.0pF* | Specification Code | Termination Code | Packaging Code |
| 0201* | 5 = 50V | J = 0±30ppm/°C | Capacitance expressed in pF. (2 significant digits + number of zeros) | P = ±0.02pF | A = Accu-F® technology | W = Nickel/Solder Coated | TR = Tape & Reel |
| 0402* | 3 = 25V | (-55°C to +125°C) | for values <10pF, letter R denotes decimal point. | Q = ±0.03pF | B = Accu-P® technology | Accu-F® Sn63, Pb37 | |
| 0603 | Y = 16V | K = 0±60ppm/°C | Example: 68pF = 680 | A = ±0.05pF | | Accu-P® 0402 Sn90, Pb10 | |
| 0805 | Z = 10V | (-55°C to +125°C) | 8.2pF = 8R2 | B = ±0.1pF | | T = Nickel/High Temperature Solder Coated | |
| 1210* | | | | C = ±0.25pF | | Accu-P® 0805** , 1210** | |
| * Accu-P ONLY | | | | for C≤3.0pF | | Sn96, Ag4 | |
| | | | | Q = ±0.03pF | | Nickel/Solder Coated | |
| | | | | A = ±0.05pF | | Accu-P® 0603 | |
| | | | | B = ±0.1pF | | Sn63, Pb37 | |
| | | | | C = ±0.25pF | | **S = Nickel/Lead Free Solder Coated | |
| | | | | for C≤5.6pF | | Accu-P® 0201 , 0402 , 0603 | |
| | | | | A = ±0.05pF | | Sn100 | |
| | | | | B = ±0.1pF | | | |
| | | | | C = ±0.25pF | | | |
| | | | | for 5.6pF<C<10pF | | | |
| | | | | B = ±0.1pF | | | |
| | | | | C = ±0.25pF | | | |
| | | | | D = ±0.5pF | | | |
| | | | | for C≥10pF | | | |
| | | | | F = ±1% | | | |
| | | | | G = ±2% | | | |
| | | | | J = ±5% | | | |

(1) TC's shown are per EIA/IEC Specifications.

Not RoHS Compliant



LEAD-FREE
LEAD-FREE COMPATIBLE COMPONENT



RoHS
COMPLIANT

For RoHS compliant products, please select correct termination style.

****RoHS compliant**

Engineering Kits Available
see pages 90-91

*Tolerances as tight as ±0.01pF are available. Please consult the factory.

ELECTRICAL SPECIFICATIONS

| | |
|---|--|
| Operating and Storage Temperature Range | -55°C to +125°C |
| Temperature Coefficients ⁽¹⁾ | 0 ± 30ppm/°C dielectric code "J" / 0 ± 60ppm/°C dielectric code "K" |
| Capacitance Measurement | 1 MHz, 1 Vrms |
| Insulation Resistance (IR) | ≥10 ¹¹ Ohms (≥10 ¹⁰ Ohms for 0201 and 0402 size) |
| Proof Voltage | 2.5 U _R for 5 secs. |
| Aging Characteristic | Zero |
| Dielectric Absorption | 0.01% |

(1) TC's shown are per EIA/IEC Specifications.



Signal Type Capacitors

Accu-F® Capacitance Ranges (pF)

TEMP. COEFFICIENT CODE

“J” = 0±30ppm/°C
(-55°C to +125°C)⁽²⁾

| Size | | - | | | ■ | | |
|--------------------------|----------|------|----|----|------|----|----|
| Size Code | | 0603 | | | 0805 | | |
| Voltage | | 100 | 50 | 25 | 100 | 50 | 25 |
| Cap in pF ⁽¹⁾ | Cap code | | | | | | |
| 0.1 | — 0R1 | | | | | | |
| 0.2 | — 0R2 | | | | | | |
| 0.3 | — 0R3 | | | | | | |
| 0.4 | — 0R4 | | | | | | |
| 0.5 | — 0R5 | | | | | | |
| 0.6 | — 0R6 | | | | | | |
| 0.7 | — 0R7 | | | | | | |
| 0.8 | — 0R8 | | | | | | |
| 0.9 | — 0R9 | | | | | | |
| 1.0 | — 1R0 | | | | | | |
| 1.2 | — 1R2 | | | | | | |
| 1.5 | — 1R5 | | | | | | |
| 1.8 | — 1R8 | | | | | | |
| 2.2 | — 2R2 | | | | | | |
| 2.7 | — 2R7 | | | | | | |
| 3.3 | — 3R3 | | | | | | |
| 3.9 | — 3R9 | | | | | | |
| 4.7 | — 4R7 | | | | | | |
| 5.6 | — 5R6 | | | | | | |
| 6.8 | — 6R8 | | | | | | |
| 8.2 | — 8R2 | | | | | | |
| 10 | — 100 | | | | | | |
| 12 | — 120 | | | | | | |
| 15 | — 150 | | | | | | |
| 18 | — 180 | | | | | | |
| 22 | — 220 | | | | | | |
| 27 | — 270 | | | | | | |
| 33 | — 330 | | | | | | |
| 39 | — 390 | | | | | | |
| 47 | — 470 | | | | | | |
| 56 | — 560 | | | | | | |
| 68 | — 680 | | | | | | |
| 82 | — 820 | | | | | | |
| 100 | — 101 | | | | | | |
| 120 | — 121 | | | | | | |
| 150 | — 151 | | | | | | |

⁽¹⁾ For capacitance values higher than listed in table, please consult factory.

⁽²⁾ TC shown is per EIA/IEC Specifications.

TEMP. COEFFICIENT CODE

“K” = 0±60ppm/°C
(-55°C to +125°C)⁽²⁾

| Size | | - | | | ■ | | |
|--------------------------|----------|------|----|----|------|----|----|
| Size Code | | 0603 | | | 0805 | | |
| Voltage | | 100 | 50 | 25 | 100 | 50 | 25 |
| Cap in pF ⁽¹⁾ | Cap code | | | | | | |
| 0.1 | — 0R1 | | | | | | |
| 0.2 | — 0R2 | | | | | | |
| 0.3 | — 0R3 | | | | | | |
| 0.4 | — 0R4 | | | | | | |
| 0.5 | — 0R5 | | | | | | |
| 0.6 | — 0R6 | | | | | | |
| 0.7 | — 0R7 | | | | | | |
| 0.8 | — 0R8 | | | | | | |
| 0.9 | — 0R9 | | | | | | |
| 1.0 | — 1R0 | | | | | | |
| 1.2 | — 1R2 | | | | | | |
| 1.5 | — 1R5 | | | | | | |
| 1.8 | — 1R8 | | | | | | |
| 2.2 | — 2R2 | | | | | | |
| 2.7 | — 2R7 | | | | | | |
| 3.3 | — 3R3 | | | | | | |
| 3.9 | — 3R9 | | | | | | |
| 4.7 | — 4R7 | | | | | | |
| 5.6 | — 5R6 | | | | | | |
| 6.8 | — 6R8 | | | | | | |
| 8.2 | — 8R2 | | | | | | |
| 10 | — 100 | | | | | | |
| 12 | — 120 | | | | | | |
| 15 | — 150 | | | | | | |
| 18 | — 180 | | | | | | |
| 22 | — 220 | | | | | | |
| 27 | — 270 | | | | | | |
| 33 | — 330 | | | | | | |
| 39 | — 390 | | | | | | |
| 47 | — 470 | | | | | | |
| 56 | — 560 | | | | | | |
| 68 | — 680 | | | | | | |
| 82 | — 820 | | | | | | |
| 100 | — 101 | | | | | | |
| 120 | — 121 | | | | | | |
| 150 | — 151 | | | | | | |

⁽¹⁾ For capacitance values higher than listed in table, please consult factory.

⁽²⁾ TC shown is per EIA/IEC Specifications.

Intermediate values are available within the indicated range.

*Not recommended for new designs.
Accu-P's are recommended.

Accu-P® Capacitance Ranges (pF)

TEMP. COEFFICIENT CODE

“J” = 0±30ppm/°C (-55°C to +125°C)⁽²⁾

| Size | | | 0201 | | | | | 0402 | | | | | 0603 | | | 0805 | | | 1210 | |
|--------------------------|---|----------|------|----|----|----|----|------|----|----|----|----|------|----|----|------|----|----|------|----|
| Size Code | | | 0201 | | | | | 0402 | | | | | 0603 | | | 0805 | | | 1210 | |
| Voltage | | | 100 | 50 | 25 | 16 | 10 | 100 | 50 | 25 | 16 | 10 | 100 | 50 | 25 | 100 | 50 | 25 | 100 | 50 |
| Cap in pF ⁽¹⁾ | — | Cap code | | | | | | | | | | | | | | | | | | |
| 0.1 | — | 0R1 | | | | | | | | | | | | | | | | | | |
| 0.2 | — | 0R2 | | | | | | | | | | | | | | | | | | |
| 0.3 | — | 0R3 | | | | | | | | | | | | | | | | | | |
| 0.4 | — | 0R4 | | | | | | | | | | | | | | | | | | |
| 0.5 | — | 0R5 | | | | | | | | | | | | | | | | | | |
| 0.6 | — | 0R6 | | | | | | | | | | | | | | | | | | |
| 0.7 | — | 0R7 | | | | | | | | | | | | | | | | | | |
| 0.8 | — | 0R8 | | | | | | | | | | | | | | | | | | |
| 0.9 | — | 0R9 | | | | | | | | | | | | | | | | | | |
| 1.0 | — | 1R0 | | | | | | | | | | | | | | | | | | |
| 1.1 | — | 1R1 | | | | | | | | | | | | | | | | | | |
| 1.2 | — | 1R2 | | | | | | | | | | | | | | | | | | |
| 1.3 | — | 1R3 | | | | | | | | | | | | | | | | | | |
| 1.4 | — | 1R4 | | | | | | | | | | | | | | | | | | |
| 1.5 | — | 1R5 | | | | | | | | | | | | | | | | | | |
| 1.6 | — | 1R6 | | | | | | | | | | | | | | | | | | |
| 1.7 | — | 1R7 | | | | | | | | | | | | | | | | | | |
| 1.8 | — | 1R8 | | | | | | | | | | | | | | | | | | |
| 1.9 | — | 1R9 | | | | | | | | | | | | | | | | | | |
| 2.0 | — | 2R0 | | | | | | | | | | | | | | | | | | |
| 2.1 | — | 2R1 | | | | | | | | | | | | | | | | | | |
| 2.2 | — | 2R2 | | | | | | | | | | | | | | | | | | |
| 2.3 | — | 2R3 | | | | | | | | | | | | | | | | | | |
| 2.4 | — | 2R4 | | | | | | | | | | | | | | | | | | |
| 2.5 | — | 2R5 | | | | | | | | | | | | | | | | | | |
| 2.6 | — | 2R6 | | | | | | | | | | | | | | | | | | |
| 2.7 | — | 2R7 | | | | | | | | | | | | | | | | | | |
| 2.8 | — | 2R8 | | | | | | | | | | | | | | | | | | |
| 2.9 | — | 2R9 | | | | | | | | | | | | | | | | | | |
| 3.0 | — | 3R0 | | | | | | | | | | | | | | | | | | |
| 3.1 | — | 3R1 | | | | | | | | | | | | | | | | | | |
| 3.2 | — | 3R2 | | | | | | | | | | | | | | | | | | |
| 3.3 | — | 3R3 | | | | | | | | | | | | | | | | | | |
| 3.4 | — | 3R4 | | | | | | | | | | | | | | | | | | |
| 3.5 | — | 3R5 | | | | | | | | | | | | | | | | | | |
| 3.6 | — | 3R6 | | | | | | | | | | | | | | | | | | |
| 3.7 | — | 3R7 | | | | | | | | | | | | | | | | | | |
| 3.8 | — | 3R8 | | | | | | | | | | | | | | | | | | |
| 3.9 | — | 3R9 | | | | | | | | | | | | | | | | | | |
| 4.0 | — | 4R0 | | | | | | | | | | | | | | | | | | |
| 4.1 | — | 4R1 | | | | | | | | | | | | | | | | | | |
| 4.2 | — | 4R2 | | | | | | | | | | | | | | | | | | |
| 4.3 | — | 4R3 | | | | | | | | | | | | | | | | | | |
| 4.4 | — | 4R4 | | | | | | | | | | | | | | | | | | |
| 4.5 | — | 4R5 | | | | | | | | | | | | | | | | | | |
| 4.6 | — | 4R6 | | | | | | | | | | | | | | | | | | |
| 4.7 | — | 4R7 | | | | | | | | | | | | | | | | | | |
| 5.1 | — | 5R1 | | | | | | | | | | | | | | | | | | |
| 5.6 | — | 5R6 | | | | | | | | | | | | | | | | | | |
| 6.2 | — | 6R2 | | | | | | | | | | | | | | | | | | |
| 6.8 | — | 6R8 | | | | | | | | | | | | | | | | | | |
| 7.5 | — | 7R5 | | | | | | | | | | | | | | | | | | |
| 8.2 | — | 8R2 | | | | | | | | | | | | | | | | | | |
| 9.1 | — | 9R1 | | | | | | | | | | | | | | | | | | |
| 10.0 | — | 100 | | | | | | | | | | | | | | | | | | |
| 11.0 | — | 110 | | | | | | | | | | | | | | | | | | |
| 12.0 | — | 120 | | | | | | | | | | | | | | | | | | |
| 13.0 | — | 130 | | | | | | | | | | | | | | | | | | |
| 14.0 | — | 140 | | | | | | | | | | | | | | | | | | |
| 15.0 | — | 150 | | | | | | | | | | | | | | | | | | |
| 16.0 | — | 160 | | | | | | | | | | | | | | | | | | |
| 17.0 | — | 170 | | | | | | | | | | | | | | | | | | |
| 18.0 | — | 180 | | | | | | | | | | | | | | | | | | |
| 19.0 | — | 190 | | | | | | | | | | | | | | | | | | |
| 20.0 | — | 200 | | | | | | | | | | | | | | | | | | |
| 21.0 | — | 210 | | | | | | | | | | | | | | | | | | |
| 22.0 | — | 220 | | | | | | | | | | | | | | | | | | |
| 24.0 | — | 240 | | | | | | | | | | | | | | | | | | |
| 27.0 | — | 270 | | | | | | | | | | | | | | | | | | |
| 30.0 | — | 300 | | | | | | | | | | | | | | | | | | |
| 33.0 | — | 330 | | | | | | | | | | | | | | | | | | |
| 39.0 | — | 390 | | | | | | | | | | | | | | | | | | |
| 47.0 | — | 470 | | | | | | | | | | | | | | | | | | |
| 56.0 | — | 560 | | | | | | | | | | | | | | | | | | |
| 68.0 | — | 680 | | | | | | | | | | | | | | | | | | |

⁽¹⁾ For capacitance values higher than listed in table, please consult factory.

⁽²⁾ TC shown is per EIA/IEC Specifications.

These values are produced with “K” temperature coefficient code only.

TEMP. COEFFICIENT CODE

“K” = 0±60ppm/°C (-55°C to +125°C)⁽²⁾

| Size | | | 805 | | | 1210 | |
|--------------------------|---|----------|-----|----|----|------|-------------------|
| Size Code | | | 805 | | | 1210 | |
| Voltage | | | 100 | 50 | 25 | 100 | 50 ⁽³⁾ |
| Cap in pF ⁽¹⁾ | — | Cap code | | | | | |
| 0.1 | — | 0R1 | | | | | |
| 0.2 | — | 0R2 | | | | | |
| 0.3 | — | 0R3 | | | | | |
| 0.4 | — | 0R4 | | | | | |
| 0.5 | — | 0R5 | | | | | |
| 0.6 | — | 0R6 | | | | | |
| 0.7 | — | 0R7 | | | | | |
| 0.8 | — | 0R8 | | | | | |
| 0.9 | — | 0R9 | | | | | |
| 1.0 | — | 1R0 | | | | | |
| 1.1 | — | 1R1 | | | | | |
| 1.2 | — | 1R2 | | | | | |
| 1.3 | — | 1R3 | | | | | |
| 1.4 | — | 1R4 | | | | | |
| 1.5 | — | 1R5 | | | | | |
| 1.6 | — | 1R6 | | | | | |
| 1.7 | — | 1R7 | | | | | |
| 1.8 | — | 1R8 | | | | | |
| 1.9 | — | 1R9 | | | | | |
| 2.0 | — | 2R0 | | | | | |
| 2.1 | — | 2R1 | | | | | |
| 2.2 | — | 2R2 | | | | | |
| 2.3 | — | 2R3 | | | | | |
| 2.4 | — | 2R4 | | | | | |
| 2.5 | — | 2R5 | | | | | |
| 2.6 | — | 2R6 | | | | | |
| 2.7 | — | 2R7 | | | | | |
| 2.8 | — | 2R8 | | | | | |
| 2.9 | — | 2R9 | | | | | |
| 3.0 | — | 3R0 | | | | | |
| 3.1 | — | 3R1 | | | | | |
| 3.2 | — | 3R2 | | | | | |
| 3.3 | — | 3R3 | | | | | |
| 3.4 | — | 3R4 | | | | | |
| 3.5 | — | 3R5 | | | | | |
| 3.6 | — | 3R6 | | | | | |
| 3.7 | — | 3R7 | | | | | |
| 3.8 | — | 3R8 | | | | | |
| 3.9 | — | 3R9 | | | | | |
| 4.0 | — | 4R0 | | | | | |
| 4.1 | — | 4R1 | | | | | |
| 4.2 | — | 4R2 | | | | | |
| 4.3 | — | 4R3 | | | | | |
| 4.4 | — | 4R4 | | | | | |
| 4.5 | — | 4R5 | | | | | |
| 4.6 | — | 4R6 | | | | | |
| 4.7 | — | 4R7 | | | | | |
| 5.1 | — | 5R1 | | | | | |
| 5.6 | — | 5R6 | | | | | |
| 6.2 | — | 6R2 | | | | | |
| 6.8 | — | 6R8 | | | | | |
| 7.5 | — | 7R5 | | | | | |
| 8.2 | — | 8R2 | | | | | |
| 9.1 | — | 9R1 | | | | | |
| 10.0 | — | 100 | | | | | |
| 11.0 | — | 110 | | | | | |
| 12.0 | — | 120 | | | | | |
| 13.0 | — | 130 | | | | | |
| 14.0 | — | 140 | | | | | |
| 15.0 | — | 150 | | | | | |
| 16.0 | — | 160 | | | | | |
| 17.0 | — | 170 | | | | | |
| 18.0 | — | 180 | | | | | |
| 19.0 | — | 190 | | | | | |
| 20.0 | — | 200 | | | | | |
| 21.0 | — | 210 | | | | | |
| 22.0 | — | 220 | | | | | |
| 24.0 | — | 240 | | | | | |
| 27.0 | — | 270 | | | | | |
| 30.0 | — | 300 | | | | | |
| 33.0 | — | 330 | | | | | |
| 39.0 | — | 390 | | | | | |
| 47.0 | — | 470 | | | | | |
| 56.0 | — | 560 | | | | | |
| 68.0 | — | 680 | | | | | |

⁽¹⁾ For capacitance values higher than listed in table, please consult factory.

0201 Typical Electrical Tables

1

| Capacitance @ 1 MHz (pF) | Self Resonance Frequency (GHz) Typical | 250MHz | | | 500MHz | | | 750MHz | | | 1000MHz | | | 1250MHz | | |
|--------------------------------|--|------------------------|-----------|---------------------|------------------------|-----------|---------------------|------------------------|-----------|---------------------|------------------------|-----------|---------------------|------------------------|-----------|---------------------|
| | | Typ. C(eff) (pF) | Typ. Q | Typ. ESR (mΩ) | Typ. C(eff) (pF) | Typ. Q | Typ. ESR (mΩ) | Typ. C(eff) (pF) | Typ. Q | Typ. ESR (mΩ) | Typ. C(eff) (pF) | Typ. Q | Typ. ESR (mΩ) | Typ. C(eff) (pF) | Typ. Q | Typ. ESR (mΩ) |
| 0.8 | 9.1 | 0.84 | 2154 | 360 | 0.84 | 630 | 603 | 0.85 | 424 | 594 | 0.85 | 327 | 577 | 0.86 | 255 | 588 |
| 1.2 | 7.6 | 1.21 | 1375 | 405 | 1.21 | 525 | 517 | 1.22 | 341 | 527 | 1.23 | 267 | 503 | 1.23 | 208 | 515 |
| 1.8 | 6.3 | 1.84 | 1298 | 271 | 1.85 | 520 | 341 | 1.86 | 337 | 347 | 1.87 | 270 | 326 | 1.88 | 201 | 347 |
| 2.2 | 5.7 | 2.23 | 1355 | 214 | 2.24 | 512 | 281 | 2.25 | 335 | 284 | 2.27 | 264 | 270 | 2.29 | 199 | 284 |
| 3.3 | 4.6 | 3.29 | 1295 | 156 | 3.31 | 430 | 230 | 3.33 | 285 | 230 | 3.36 | 220 | 223 | 3.40 | 159 | 242 |
| 3.9 | 4.3 | 3.91 | 1902 | 93 | 3.93 | 460 | 181 | 3.97 | 298 | 185 | 4.02 | 227 | 181 | 4.08 | 163 | 198 |
| 4.7 | 3.9 | 4.71 | 1677 | 84 | 4.74 | 391 | 174 | 4.80 | 252 | 178 | 4.87 | 181 | 183 | 4.97 | 130 | 200 |
| 5.6 | 3.6 | 5.62 | 1391 | 84 | 5.67 | 370 | 154 | 5.74 | 257 | 148 | 5.83 | 195 | 144 | 5.95 | 140 | 157 |
| 6.8 | 3.3 | 6.77 | 1135 | 84 | 6.83 | 314 | 149 | 6.91 | 217 | 142 | 7.03 | 164 | 139 | 7.18 | 118 | 151 |

| Capacitance @ 1 MHz (pF) | Self Resonance Frequency (GHz) Typical | 1500MHz | | | 1750MHz | | | 2250MHz | | | 2500MHz | | | 2750MHz | | |
|--------------------------------|--|------------------------|-----------|---------------------|------------------------|-----------|---------------------|------------------------|-----------|---------------------|------------------------|----------------|---------------------|------------------------|-----------|---------------------|
| | | Typ. C(eff) (pF) | Typ. Q | Typ. ESR (mΩ) | Typ. C(eff) (pF) | Typ. Q | Typ. ESR (mΩ) | Typ. C(eff) (pF) | Typ. Q | Typ. ESR (mΩ) | Typ. C(eff) (pF) | Typ. Q M | Typ. ESR (mΩ) | Typ. C(eff) (pF) | Typ. Q | Typ. ESR (mΩ) |
| 0.8 | 9.1 | 0.86 | 204 | 611 | 0.87 | 168 | 631 | 0.88 | 141 | 587 | 0.89 | 126 | 571 | 0.90 | 122 | 532 |
| 1.2 | 7.6 | 1.24 | 155 | 565 | 1.26 | 129 | 577 | 1.28 | 92 | 570 | 1.30 | 89 | 566 | 1.31 | 81 | 558 |
| 1.8 | 6.3 | 1.90 | 148 | 388 | 1.92 | 123 | 395 | 1.96 | 96 | 395 | 1.99 | 83 | 396 | 2.02 | 74 | 397 |
| 2.2 | 5.7 | 2.32 | 145 | 320 | 2.34 | 123 | 322 | 2.41 | 93 | 329 | 2.46 | 81 | 328 | 2.50 | 72 | 330 |
| 3.3 | 4.6 | 3.45 | 119 | 266 | 3.50 | 101 | 263 | 3.63 | 74 | 277 | 3.73 | 64 | 276 | 3.84 | 55 | 281 |
| 3.9 | 4.3 | 4.16 | 122 | 216 | 4.25 | 103 | 214 | 4.46 | 75 | 224 | 4.63 | 64 | 223 | 4.79 | 56 | 225 |
| 4.7 | 3.9 | 5.08 | 99 | 213 | 5.23 | 83 | 212 | 5.55 | 60 | 221 | 5.83 | 50 | 222 | 6.10 | 43 | 224 |
| 5.6 | 3.6 | 6.11 | 108 | 166 | 6.31 | 91 | 164 | 6.76 | 64 | 174 | 7.16 | 53 | 175 | 7.56 | 45 | 141 |
| 6.8 | 3.3 | 7.38 | 93 | 155 | 7.63 | 76 | 158 | 8.22 | 54 | 166 | 8.74 | 44 | 169 | 9.29 | 37 | 173 |

0402 Typical Electrical Tables

| Capacitance & Tolerance* @ 1 MHz (pF) | Self Resonance Frequency (GHz) Typical | Ref Freq (MHz) | Typ. C(eff) (pF) | Typ. Q | Typ. ESR (Ω) | Ref Freq (MHz) | Typ. C(eff) (pF) | Typ. Q | Typ. ESR (Ω) | Ref Freq (MHz) | Typ. C(eff) (pF) | Typ. Q | Typ. ESR (Ω) | Ref Freq (MHz) | Typ. C(eff) (pF) | Typ. Q | Typ. ESR (Ω) | Ref Freq (MHz) | Typ. C(eff) (pF) | Typ. Q | Typ. ESR (Ω) | |
|---------------------------------------|--|----------------|------------------|--------|--------------|----------------|------------------|--------|--------------|----------------|------------------|--------|--------------|----------------|------------------|--------|--------------|----------------|------------------|--------|--------------|------|
| 0.1±0.05 | 19.4 | n/a | n/a | n/a | n/a | n/a | n/a | n/a | n/a | n/a | n/a | n/a | n/a | n/a | n/a | n/a | n/a | n/a | n/a | n/a | n/a | n/a |
| 0.2±0.05 | 16.4 | n/a | n/a | n/a | n/a | n/a | n/a | n/a | n/a | n/a | n/a | n/a | n/a | n/a | n/a | n/a | n/a | n/a | n/a | n/a | n/a | n/a |
| 0.3±0.05 | 14.6 | n/a | n/a | n/a | n/a | n/a | n/a | n/a | n/a | n/a | n/a | n/a | n/a | n/a | n/a | n/a | n/a | n/a | n/a | n/a | n/a | n/a |
| 0.4±0.05 | 12.5 | n/a | n/a | n/a | n/a | n/a | n/a | n/a | n/a | n/a | n/a | n/a | n/a | n/a | n/a | n/a | n/a | n/a | n/a | n/a | n/a | n/a |
| 0.5±0.05 | 11.3 | n/a | n/a | n/a | n/a | n/a | n/a | n/a | n/a | n/a | n/a | n/a | n/a | n/a | n/a | n/a | n/a | n/a | n/a | n/a | n/a | n/a |
| 0.6±0.05 | 10.4 | n/a | n/a | n/a | n/a | n/a | n/a | n/a | n/a | n/a | n/a | n/a | n/a | n/a | n/a | n/a | n/a | n/a | n/a | n/a | n/a | n/a |
| 0.7±0.05 | 9.5 | n/a | n/a | n/a | n/a | n/a | n/a | n/a | n/a | n/a | n/a | n/a | n/a | n/a | n/a | n/a | n/a | n/a | n/a | n/a | n/a | n/a |
| 0.8±0.05 | 9.1 | n/a | n/a | n/a | n/a | n/a | n/a | n/a | n/a | n/a | n/a | n/a | n/a | n/a | n/a | n/a | n/a | n/a | n/a | n/a | n/a | n/a |
| 0.9±0.05 | 8.8 | n/a | n/a | n/a | n/a | n/a | n/a | n/a | n/a | n/a | n/a | n/a | n/a | n/a | n/a | n/a | n/a | n/a | n/a | n/a | n/a | n/a |
| 1.00±0.05 | 8 | 247 | 1.16 | 1635 | 0.34 | 494 | 1.15 | 1283 | 0.22 | 742 | 1.13 | 870 | 0.22 | 991 | 1.12 | 620 | 0.23 | 1240 | 1.14 | 474 | 0.25 | 0.25 |
| 1.10±0.05 | 7.8 | 246 | 1.25 | 1581 | 0.32 | 492 | 1.22 | 1219 | 0.21 | 740 | 1.21 | 791 | 0.22 | 989 | 1.19 | 561 | 0.24 | 1238 | 1.21 | 425 | 0.25 | 0.25 |
| 1.20±0.05 | 7.4 | 245 | 1.34 | 1538 | 0.30 | 491 | 1.33 | 1153 | 0.21 | 738 | 1.31 | 727 | 0.22 | 986 | 1.3 | 503 | 0.25 | 1234 | 1.33 | 372 | 0.25 | 0.25 |
| 1.30±0.05 | 7 | 244 | 1.42 | 1502 | 0.29 | 490 | 1.42 | 1109 | 0.21 | 736 | 1.4 | 701 | 0.21 | 983 | 1.35 | 480 | 0.24 | 1230 | 1.41 | 350 | 0.25 | 0.25 |
| 1.40±0.05 | 6.8 | 243 | 1.53 | 1476 | 0.28 | 488 | 1.54 | 1061 | 0.20 | 733 | 1.52 | 680 | 0.21 | 980 | 1.49 | 461 | 0.23 | 1229 | 1.53 | 333 | 0.25 | 0.25 |
| 1.50±0.05 | 6.5 | 242 | 1.63 | 1454 | 0.28 | 486 | 1.63 | 1002 | 0.20 | 731 | 1.58 | 638 | 0.21 | 978 | 1.6 | 438 | 0.23 | 1226 | 1.65 | 316 | 0.25 | 0.25 |
| 1.60±0.05 | 6.5 | 242 | 1.71 | 1448 | 0.27 | 485 | 1.76 | 986 | 0.20 | 729 | 1.69 | 622 | 0.21 | 986 | 1.71 | 429 | 0.23 | 1224 | 1.77 | 309 | 0.24 | 0.24 |
| 1.70±0.05 | 6.4 | 241 | 1.85 | 1444 | 0.27 | 483 | 1.81 | 970 | 0.19 | 728 | 1.75 | 612 | 0.20 | 985 | 1.75 | 422 | 0.22 | 1223 | 1.86 | 305 | 0.23 | 0.23 |
| 1.80±0.05 | 6.2 | 240 | 1.93 | 1430 | 0.26 | 482 | 1.86 | 931 | 0.19 | 727 | 1.83 | 597 | 0.20 | 983 | 1.8 | 413 | 0.22 | 1220 | 1.91 | 299 | 0.23 | 0.23 |
| 1.90±0.05 | 6 | 239 | 2.01 | 1421 | 0.25 | 481 | 1.93 | 897 | 0.19 | 726 | 1.91 | 583 | 0.20 | 972 | 1.91 | 401 | 0.21 | 1219 | 1.97 | 294 | 0.22 | 0.22 |
| 2.00±0.05 | 5.7 | 239 | 2.11 | 1410 | 0.24 | 480 | 2.06 | 896 | 0.18 | 722 | 2.11 | 582 | 0.19 | 969 | 2.01 | 400 | 0.20 | 1215 | 2.11 | 293 | 0.21 | 0.21 |
| 2.10±0.05 | 5.4 | 238 | 2.21 | 1406 | 0.23 | 478 | 2.14 | 893 | 0.17 | 720 | 2.21 | 581 | 0.18 | 966 | 2.1 | 398 | 0.19 | 1213 | 2.22 | 291 | 0.20 | 0.20 |
| 2.20±0.05 | 5.1 | 237 | 2.28 | 1406 | 0.22 | 476 | 2.27 | 893 | 0.16 | 718 | 2.26 | 581 | 0.17 | 964 | 2.27 | 396 | 0.18 | 1212 | 2.25 | 289 | 0.19 | 0.19 |
| 2.30±0.05 | 5 | 237 | 2.32 | 1405 | 0.20 | 475 | 2.36 | 870 | 0.16 | 716 | 2.4 | 549 | 0.17 | 962 | 2.3 | 379 | 0.18 | 1209 | 2.4 | 262 | 0.20 | 0.20 |
| 2.40±0.05 | 4.9 | 236 | 2.45 | 1404 | 0.19 | 473 | 2.48 | 845 | 0.16 | 715 | 2.51 | 501 | 0.17 | 960 | 2.41 | 358 | 0.19 | 1208 | 2.53 | 253 | 0.20 | 0.20 |
| 2.50±0.05 | 4.7 | 235 | 2.49 | 1404 | 0.18 | 472 | 2.6 | 821 | 0.16 | 714 | 2.62 | 486 | 0.17 | 959 | 2.52 | 349 | 0.19 | 1205 | 2.7 | 240 | 0.20 | 0.20 |
| 2.60±0.05 | 4.6 | 234 | 2.6 | 1402 | 0.16 | 470 | 2.71 | 799 | 0.15 | 712 | 2.73 | 477 | 0.17 | 958 | 2.65 | 331 | 0.19 | 1204 | 2.85 | 231 | 0.20 | 0.20 |
| 2.70±0.05 | 4.5 | 233 | 2.84 | 1399 | 0.15 | 469 | 2.83 | 778 | 0.15 | 711 | 2.82 | 464 | 0.17 | 956 | 2.86 | 313 | 0.19 | 1203 | 3 | 224 | 0.20 | 0.20 |
| 2.80±0.05 | 4.5 | 233 | 2.85 | 1395 | 0.15 | 468 | 2.94 | 769 | 0.15 | 710 | 2.9 | 458 | 0.16 | 954 | 2.91 | 308 | 0.18 | 1202 | 3.12 | 220 | 0.20 | 0.20 |
| 2.90±0.05 | 4.4 | 232 | 2.87 | 1395 | 0.15 | 467 | 3.11 | 751 | 0.15 | 710 | 2.99 | 450 | 0.16 | 953 | 3.15 | 303 | 0.18 | 1201 | 3.24 | 218 | 0.19 | 0.19 |
| 3.00±0.05 | 4.4 | 231 | 2.88 | 1392 | 0.14 | 466 | 3.39 | 746 | 0.15 | 709 | 3.11 | 440 | 0.16 | 952 | 3.41 | 299 | 0.18 | 1201 | 3.33 | 212 | 0.19 | 0.19 |
| 3.10±0.05 | 4.4 | 230 | 2.9 | 1392 | 0.14 | 465 | 3.45 | 733 | 0.15 | 708 | 3.22 | 429 | 0.16 | 951 | 3.48 | 291 | 0.18 | 1199 | 3.45 | 207 | 0.19 | 0.19 |
| 3.20±0.05 | 4.3 | 230 | 2.91 | 1391 | 0.14 | 464 | 3.61 | 725 | 0.15 | 707 | 3.3 | 421 | 0.16 | 950 | 3.68 | 285 | 0.17 | 1198 | 3.58 | 203 | 0.19 | 0.19 |
| 3.30±0.05 | 4.3 | 229 | 2.92 | 1391 | 0.14 | 462 | 3.72 | 711 | 0.14 | 707 | 3.42 | 415 | 0.16 | 949 | 3.8 | 282 | 0.17 | 1197 | 3.61 | 198 | 0.19 | 0.19 |
| 3.40±0.05 | 4.3 | 228 | 2.93 | 1390 | 0.14 | 461 | 3.78 | 705 | 0.14 | 706 | 3.53 | 407 | 0.15 | 948 | 3.79 | 276 | 0.17 | 1196 | 3.78 | 195 | 0.19 | 0.19 |
| 3.50±0.05 | 4.2 | 227 | 2.95 | 1389 | 0.13 | 460 | 3.82 | 693 | 0.14 | 705 | 3.6 | 402 | 0.15 | 947 | 3.85 | 273 | 0.16 | 1195 | 3.91 | 191 | 0.18 | 0.18 |
| 3.60±0.05 | 4.2 | 226 | 2.97 | 1382 | 0.13 | 459 | 3.87 | 688 | 0.14 | 704 | 3.7 | 395 | 0.15 | 946 | 3.89 | 270 | 0.16 | 1194 | 4 | 186 | 0.18 | 0.18 |
| 3.70±0.05 | 4.1 | 226 | 2.99 | 1381 | 0.13 | 458 | 3.93 | 667 | 0.14 | 702 | 3.81 | 389 | 0.15 | 945 | 3.95 | 262 | 0.16 | 1193 | 4.1 | 181 | 0.18 | 0.18 |
| 3.80±0.05 | 4 | 225 | 4 | 1380 | 0.13 | 458 | 4 | 658 | 0.13 | 699 | 3.9 | 386 | 0.15 | 944 | 4.02 | 256 | 0.16 | 1192 | 4.23 | 177 | 0.18 | 0.18 |
| 3.90±0.05 | 3.9 | 224 | 4.01 | 1379 | 0.13 | 457 | 4.01 | 649 | 0.13 | 697 | 4.02 | 384 | 0.15 | 943 | 4.11 | 251 | 0.16 | 1191 | 4.37 | 172 | 0.18 | 0.18 |
| 4.00±0.05 | 3.9 | 224 | 4.09 | 1372 | 0.12 | 457 | 4.07 | 650 | 0.13 | 696 | 4.11 | 381 | 0.14 | 942 | 4.18 | 250 | 0.16 | 1190 | 4.46 | 170 | 0.18 | 0.18 |
| 4.10±0.05 | 3.8 | 223 | 4.18 | 1370 | 0.12 | 456 | 4.18 | 655 | 0.13 | 696 | 4.2 | 380 | 0.14 | 941 | 4.23 | 248 | 0.15 | 1190 | 4.52 | 169 | 0.17 | 0.17 |
| 4.20±0.05 | 3.8 | 223 | 4.27 | 1356 | 0.12 | 455 | 4.27 | 658 | 0.12 | 695 | 4.29 | 379 | 0.14 | 940 | 4.37 | 247 | 0.15 | 1199 | 4.66 | 167 | 0.17 | 0.17 |
| 4.30±0.05 | 3.7 | 222 | 4.36 | 1355 | 0.12 | 454 | 4.34 | 657 | 0.12 | 694 | 4.43 | 373 | 0.14 | 939 | 4.58 | 246 | 0.15 | 1195 | 4.75 | 168 | 0.17 | 0.17 |
| 4.40±0.05 | 3.7 | 222 | 4.44 | 1351 | 0.11 | 453 | 4.45 | 660 | 0.12 | 693 | 4.5 | 369 | 0.14 | 939 | 4.62 | 246 | 0.14 | 1192 | 4.82 | 162 | 0.16 | 0.16 |
| 4.50±0.05 | 3.6 | 221 | 4.53 | 1350 | 0.11 | 452 | 4.52 | 665 | 0.12 | 692 | 4.6 | 364 | 0.13 | 938 | 4.7 | 245 | 0.14 | 1190 | 4.96 | 161 | 0.16 | 0.16 |
| 4.60±0.05 | 3.6 | 221 | 4.62 | 1347 | 0.11 | 451 | 4.62 | 670 | 0.11 | 691 | 4.72 | 359 | 0.13 | 938 | 4.79 | 244 | 0.14 | 1188 | 5.07 | 161 | 0.16 | 0.16 |
| 4.70±0.05 | 3.5 | 220 | 4.75 | 1343 | 0.11 | 450 | 4.74 | 673 | 0.11 | 690 | 4.74 | 351 | 0.13 | 937 | 4.86 | 244 | 0.14 | 1186 | 5.18 | 159 | 0.16 | 0.16 |
| 5.10±0.05 | 3.4 | 217 | 5.19 | 1310 | 0.11 | 447 | 5.16 | 589 | 0.11 | 687 | 5.23 | 348 | 0.13 | 934 | 5.53 | 230 | 0.14 | 1184 | 5.82 | 131 | 0.16 | 0.16 |
| 5.60±0.05 | 3.3 | 214 | 5.74 | 1297 | 0.11 | 443 | 5.75 | 576 | 0.11 | 684 | 5.81 | 342 | 0.12 | 932 | 6.01 | 201 | 0.14 | 1182 | 6.62 | 129 | 0.16 | 0.16 |
| 6.2±0.1 | 3 | 211 | 6.31 | 1244 | 0.10 | 440 | 6.09 | 585 | 0.10 | 681 | 6.33 | 339 | 0.11 | 928 | 6.68 | 202 | 0.12 | 1180 | 7.34 | 128 | 0.15 | 0.15 |
| 6.8±0.1 | 2.8 | 208 | 6.92 | 1202 | 0.09 | 436 | 6.94 | 591 | 0.09 | 678 | 7.04 | 334 | 0.10 | 926 | 7.39 | 203 | 0.11 | 1177 | 8.22 | 127 | 0.14 | 0.14 |
| 7.5±0.1 | 2.7 | 205 | 7.57 | 1155 | 0.08 | 433 | 7.51 | 567 | 0.09 | 675 | 7.85 | 320 | 0.10 | 924 | 8.17 | 191 | 0.10 | 1176 | 9.01 | 120 | 0.13 | 0.13 |
| 8.2±0.1 | 2.6 | 202 | 8.35 | 1116 | 0.08 | 430 | 8.36 | 542 | 0.08 | 673 | 8.48 | 306 | 0.09 | 922 | 8.93 | 186 | 0.10 | 1174 | 10.04 | 118 | 0.13 | 0.13 |
| 9.1±0.1 | 2.5 | 199 | 9.23 | 1059 | 0.09 | 428 | 9.28 | 458 | 0.09 | 670 | 9.87 | 249 | 0.10 | 920 | 10.2 | 152 | 0.11 | 1172 | 11.98 | 88 | 0.13 | 0.13 |
| 10.0±1% | 2.4 | 196 | 10.14 | 936 | 0.09 | 424 | 10.24 | 385 | 0.10 | 668 | 10.55 | 202 | 0.11 | 919 | 11.49 | 118 | 0.13 | 1171 | 13.75 | 70 | 0.12 | 0.12 |
| 11.0±1% | 2.3 | 193 | 11.19 | 912 | 0.08 | 421 | 11.17 | 363 | 0.09 | 666 | 11.81 | 185 | 0.11 | 917 | 12.87 | 103 | 0.12 | 1170 | 15.3 | 61 | 0.12 | 0.12 |
| 12.0±1% | 2.2 | 189 | 12.16 | 889 | 0.08 | 418 | 12.3 | 348 | 0.09 | 664 | 12.77 | 173 | 0.11 | 915 | 14.16 | 95 | 0.13 | 1168 | 17.63 | 52 | 0.12 | 0.12 |
| 13.0±1% | 2.2 | 186 | 13.3 | 984 | 0.07 | 416 | 13.32 | 363 | 0.08 | 661 | 14.1 | 183 | 0.09 | 912 | 15.8 | 101 | 0.11 | 1164 | 23.9 | 47 | 0.12 | 0.12 |
| 14.0±1% | 2.1 | 184 | 14.26 | 802 | 0.08 | 414 | 14.44 | 298 | 0.09 | 660 | 15.03 | 149 | 0.12 | 913 | 16.72 | 76.7 | 0.14 | 1167 | 23.1 | 40 | 0.15 | 0.15 |
| 15.0±1% | 2.1 | 182 | 15.34 | 791 | 0.07 | 413 | 15.46 | 283 | 0.08 | 660 | 16.16 | 138 | 0.10 | 912 | 18.51 | 82 | 0.16 | 1166 | 23.6 | 44 | 0.13 | 0.13 |
| 16.0 | | | | | | | | | | | | | | | | | | | | | | |

0402 Typical Electrical Tables

| Capacitance & Tolerance* @ 1 MHz (pF) | Self Resonance Frequency (GHz) Typical | Ref Freq (MHz) | Typ. C(eff) (pF) | Typ. Q | Typ. ESR (Ω) | Ref Freq (MHz) | Typ. C(eff) (pF) | Typ. Q | Typ. ESR (Ω) | Ref Freq (MHz) | Typ. C(eff) (pF) | Typ. Q | Typ. ESR (Ω) | Ref Freq (MHz) | Typ. C(eff) (pF) | Typ. Q | Typ. ESR (Ω) | Ref Freq (MHz) | Typ. C(eff) (pF) | Typ. Q | Typ. ESR (Ω) | |
|---------------------------------------|--|----------------|------------------|--------|--------------|----------------|------------------|--------|--------------|----------------|------------------|--------|--------------|----------------|------------------|--------|--------------|----------------|------------------|--------|--------------|-----|
| 0.1±0.05 | 19.4 | n/a | n/a | n/a | n/a | n/a | n/a | n/a | n/a | n/a | n/a | n/a | n/a | n/a | n/a | n/a | n/a | n/a | n/a | n/a | n/a | n/a |
| 0.2±0.05 | 16.4 | n/a | n/a | n/a | n/a | n/a | n/a | n/a | n/a | n/a | n/a | n/a | n/a | n/a | n/a | n/a | n/a | n/a | n/a | n/a | n/a | n/a |
| 0.3±0.05 | 14.6 | n/a | n/a | n/a | n/a | n/a | n/a | n/a | n/a | n/a | n/a | n/a | n/a | n/a | n/a | n/a | n/a | n/a | n/a | n/a | n/a | n/a |
| 0.4±0.05 | 12.5 | n/a | n/a | n/a | n/a | n/a | n/a | n/a | n/a | n/a | n/a | n/a | n/a | n/a | n/a | n/a | n/a | n/a | n/a | n/a | n/a | n/a |
| 0.5±0.05 | 11.3 | n/a | n/a | n/a | n/a | n/a | n/a | n/a | n/a | n/a | n/a | n/a | n/a | n/a | n/a | n/a | n/a | n/a | n/a | n/a | n/a | n/a |
| 0.6±0.05 | 10.4 | n/a | n/a | n/a | n/a | n/a | n/a | n/a | n/a | n/a | n/a | n/a | n/a | n/a | n/a | n/a | n/a | n/a | n/a | n/a | n/a | n/a |
| 0.7±0.05 | 9.5 | n/a | n/a | n/a | n/a | n/a | n/a | n/a | n/a | n/a | n/a | n/a | n/a | n/a | n/a | n/a | n/a | n/a | n/a | n/a | n/a | n/a |
| 0.8±0.05 | 9.1 | n/a | n/a | n/a | n/a | n/a | n/a | n/a | n/a | n/a | n/a | n/a | n/a | n/a | n/a | n/a | n/a | n/a | n/a | n/a | n/a | n/a |
| 0.9±0.05 | 8.8 | n/a | n/a | n/a | n/a | n/a | n/a | n/a | n/a | n/a | n/a | n/a | n/a | n/a | n/a | n/a | n/a | n/a | n/a | n/a | n/a | n/a |
| 1.00±0.05 | 8 | 1489 | 1.18 | 380 | 0.25 | 1739 | 1.25 | 314 | 0.25 | 1988 | 1.32 | 265 | 0.24 | 2240 | 1.38 | 229 | 0.23 | 2493 | 1.41 | 200 | 0.23 | |
| 1.10±0.05 | 7.8 | 1485 | 1.29 | 342 | 0.25 | 1735 | 1.33 | 275 | 0.25 | 1986 | 1.41 | 232 | 0.24 | 2238 | 1.49 | 201 | 0.24 | 2490 | 1.55 | 177 | 0.25 | |
| 1.20±0.05 | 7.4 | 1483 | 1.37 | 307 | 0.25 | 1732 | 1.45 | 251 | 0.25 | 1982 | 1.54 | 208 | 0.24 | 2234 | 1.59 | 173 | 0.25 | 2488 | 1.62 | 149 | 0.27 | |
| 1.30±0.05 | 7 | 1479 | 1.45 | 289 | 0.25 | 1729 | 1.58 | 240 | 0.25 | 1980 | 1.66 | 196 | 0.24 | 2230 | 1.73 | 166 | 0.25 | 2485 | 1.76 | 137 | 0.27 | |
| 1.40±0.05 | 6.8 | 1477 | 1.6 | 265 | 0.25 | 1726 | 1.71 | 221 | 0.25 | 1977 | 1.78 | 179 | 0.24 | 2229 | 1.88 | 154 | 0.25 | 2483 | 1.89 | 125 | 0.26 | |
| 1.50±0.05 | 6.5 | 1474 | 1.72 | 252 | 0.25 | 1724 | 1.82 | 203 | 0.25 | 1974 | 1.94 | 169 | 0.24 | 2227 | 2.01 | 143 | 0.25 | 2481 | 2.03 | 115 | 0.27 | |
| 1.60±0.05 | 6.5 | 1472 | 1.81 | 246 | 0.24 | 1722 | 1.91 | 201 | 0.24 | 1971 | 2.01 | 168 | 0.23 | 2226 | 2.1 | 142 | 0.24 | 2479 | 2.1 | 119 | 0.25 | |
| 1.70±0.05 | 6.4 | 1470 | 1.92 | 241 | 0.23 | 1719 | 1.99 | 199 | 0.23 | 1970 | 2.1 | 167 | 0.22 | 2225 | 2.23 | 141 | 0.23 | 2478 | 2.23 | 120 | 0.24 | |
| 1.80±0.05 | 6.2 | 1469 | 1.98 | 240 | 0.22 | 1718 | 2.06 | 198 | 0.22 | 1969 | 2.24 | 166 | 0.21 | 2223 | 2.34 | 141 | 0.22 | 2477 | 2.35 | 122 | 0.22 | |
| 1.90±0.05 | 6 | 1468 | 2.06 | 239 | 0.22 | 1717 | 2.19 | 197 | 0.21 | 1968 | 2.33 | 165 | 0.21 | 2222 | 2.41 | 140 | 0.21 | 2476 | 2.42 | 123 | 0.21 | |
| 2.00±0.05 | 5.7 | 1466 | 2.12 | 233 | 0.21 | 1716 | 2.22 | 190 | 0.21 | 1968 | 2.51 | 160 | 0.20 | 2220 | 2.62 | 138 | 0.21 | 2475 | 2.65 | 118 | 0.21 | |
| 2.10±0.05 | 5.4 | 1463 | 2.31 | 230 | 0.20 | 1714 | 2.43 | 185 | 0.21 | 1966 | 2.62 | 155 | 0.20 | 2219 | 2.76 | 132 | 0.2 | 2474 | 2.81 | 115 | 0.20 | |
| 2.20±0.05 | 5.1 | 1461 | 2.47 | 228 | 0.20 | 1711 | 2.65 | 183 | 0.20 | 1964 | 2.83 | 149 | 0.20 | 2217 | 2.91 | 126 | 0.19 | 2473 | 2.91 | 108 | 0.20 | |
| 2.30±0.05 | 5 | 1460 | 2.51 | 214 | 0.20 | 1709 | 2.81 | 168 | 0.20 | 1963 | 2.98 | 132 | 0.19 | 2216 | 3.15 | 121 | 0.19 | 2471 | 3.16 | 99 | 0.22 | |
| 2.40±0.05 | 4.9 | 1459 | 2.6 | 196 | 0.20 | 1708 | 3 | 151 | 0.20 | 1962 | 3.16 | 120 | 0.19 | 2215 | 3.42 | 109 | 0.2 | 2469 | 3.42 | 91 | 0.23 | |
| 2.50±0.05 | 4.7 | 1458 | 2.77 | 182 | 0.20 | 1706 | 3.12 | 144 | 0.20 | 1960 | 3.32 | 112 | 0.19 | 2214 | 3.58 | 92 | 0.21 | 2468 | 3.66 | 81 | 0.23 | |
| 2.60±0.05 | 4.6 | 1455 | 2.85 | 173 | 0.20 | 1705 | 3.25 | 132 | 0.20 | 1957 | 3.51 | 97 | 0.19 | 2212 | 3.73 | 85 | 0.22 | 2467 | 3.73 | 72 | 0.24 | |
| 2.70±0.05 | 4.5 | 1453 | 3.18 | 164 | 0.20 | 1703 | 3.47 | 122 | 0.20 | 1956 | 3.75 | 94 | 0.20 | 2211 | 3.89 | 78 | 0.24 | 2466 | 3.89 | 66 | 0.25 | |
| 2.80±0.05 | 4.5 | 1451 | 3.25 | 159 | 0.20 | 1702 | 3.62 | 120 | 0.20 | 1956 | 3.93 | 88 | 0.20 | 2210 | 3.97 | 75 | 0.24 | 2466 | 4.03 | 65 | 0.25 | |
| 2.90±0.05 | 4.4 | 1450 | 3.33 | 156 | 0.19 | 1702 | 3.77 | 117 | 0.20 | 1956 | 4.02 | 84 | 0.20 | 2210 | 4.12 | 73 | 0.24 | 2466 | 4.17 | 63 | 0.25 | |
| 3.00±0.05 | 4.4 | 1449 | 3.49 | 150 | 0.19 | 1701 | 3.99 | 114 | 0.20 | 1955 | 4.21 | 81 | 0.20 | 2209 | 4.26 | 72 | 0.24 | 2465 | 4.21 | 61 | 0.25 | |
| 3.10±0.05 | 4.4 | 1448 | 3.61 | 148 | 0.19 | 1700 | 4.16 | 109 | 0.20 | 1952 | 4.4 | 79 | 0.20 | 2209 | 4.45 | 70 | 0.24 | 2465 | 4.33 | 59 | 0.25 | |
| 3.20±0.05 | 4.3 | 1447 | 3.7 | 145 | 0.19 | 1700 | 4.31 | 105 | 0.20 | 1952 | 4.62 | 77 | 0.19 | 2208 | 4.62 | 69 | 0.23 | 2464 | 4.49 | 58 | 0.25 | |
| 3.30±0.05 | 4.3 | 1446 | 3.79 | 143 | 0.19 | 1699 | 4.47 | 101 | 0.20 | 1951 | 4.76 | 76 | 0.20 | 2207 | 4.81 | 68 | 0.23 | 2464 | 4.66 | 55 | 0.25 | |
| 3.40±0.05 | 4.3 | 1446 | 4.01 | 138 | 0.19 | 1698 | 4.62 | 101 | 0.20 | 1950 | 4.92 | 75 | 0.20 | 2206 | 4.93 | 66 | 0.22 | 2464 | 4.92 | 52 | 0.24 | |
| 3.50±0.05 | 4.2 | 1445 | 4.11 | 133 | 0.19 | 1697 | 4.78 | 95 | 0.20 | 1950 | 5.18 | 73 | 0.19 | 2206 | 5.21 | 65 | 0.23 | 2463 | 5.15 | 51 | 0.24 | |
| 3.60±0.05 | 4.2 | 1445 | 4.2 | 130 | 0.19 | 1697 | 4.91 | 94 | 0.20 | 1949 | 5.34 | 71 | 0.20 | 2205 | 5.4 | 63 | 0.22 | 2463 | 5.25 | 51 | 0.24 | |
| 3.70±0.05 | 4.1 | 1444 | 4.28 | 126 | 0.19 | 1696 | 5.05 | 92 | 0.19 | 1949 | 5.5 | 69 | 0.20 | 2205 | 5.62 | 62 | 0.22 | 2462 | 5.41 | 49 | 0.24 | |
| 3.80±0.05 | 4 | 1443 | 4.44 | 125 | 0.19 | 1696 | 5.11 | 90 | 0.19 | 1948 | 5.61 | 67 | 0.20 | 2204 | 5.78 | 61 | 0.22 | 2462 | 5.66 | 48 | 0.24 | |
| 3.90±0.05 | 3.9 | 1442 | 4.72 | 121 | 0.19 | 1695 | 5.26 | 89 | 0.19 | 1948 | 5.77 | 66 | 0.21 | 2204 | 5.94 | 60 | 0.22 | 2461 | 5.82 | 47 | 0.24 | |
| 4.00±0.05 | 3.9 | 1441 | 4.8 | 121 | 0.18 | 1694 | 5.38 | 88 | 0.19 | 1947 | 5.81 | 66 | 0.20 | 2203 | 6.03 | 60 | 0.21 | 2461 | 5.86 | 48 | 0.23 | |
| 4.10±0.05 | 3.8 | 1440 | 4.92 | 121 | 0.18 | 1693 | 5.5 | 87 | 0.19 | 1947 | 5.93 | 65 | 0.19 | 2203 | 6.11 | 60 | 0.21 | 2460 | 5.9 | 49 | 0.23 | |
| 4.20±0.05 | 3.8 | 1440 | 5.01 | 120 | 0.18 | 1692 | 5.63 | 87 | 0.18 | 1946 | 6.05 | 65 | 0.18 | 2203 | 6.24 | 59 | 0.21 | 2460 | 5.95 | 49 | 0.21 | |
| 4.30±0.05 | 3.7 | 1439 | 5.17 | 120 | 0.18 | 1692 | 5.78 | 85 | 0.18 | 1946 | 6.11 | 64 | 0.18 | 2202 | 6.35 | 58 | 0.2 | 2459 | 6.01 | 50 | 0.20 | |
| 4.40±0.05 | 3.7 | 1439 | 5.28 | 119 | 0.18 | 1691 | 5.91 | 85 | 0.18 | 1945 | 6.23 | 64 | 0.18 | 2202 | 6.4 | 57 | 0.2 | 2459 | 6.12 | 52 | 0.20 | |
| 4.50±0.05 | 3.6 | 1438 | 5.41 | 119 | 0.18 | 1691 | 6.04 | 81 | 0.18 | 1945 | 6.45 | 64 | 0.19 | 2201 | 6.52 | 56 | 0.19 | 2458 | 6.23 | 52 | 0.19 | |
| 4.60±0.05 | 3.6 | 1438 | 5.49 | 118 | 0.17 | 1691 | 6.11 | 80 | 0.18 | 1944 | 6.66 | 63 | 0.17 | 2201 | 6.67 | 55 | 0.18 | 2458 | 6.29 | 54 | 0.19 | |
| 4.70±0.05 | 3.5 | 1437 | 5.6 | 118 | 0.17 | 1690 | 6.23 | 80 | 0.18 | 1944 | 6.72 | 63 | 0.17 | 2200 | 6.71 | 56 | 0.18 | 2457 | 6.35 | 54 | 0.19 | |
| 5.10±0.05 | 3.4 | 1435 | 6.59 | 105 | 0.17 | 1689 | 7.48 | 75 | 0.18 | 1943 | 7.97 | 60 | 0.19 | 2200 | 8.11 | 45 | 0.2 | 2456 | 8.1 | 39 | 0.21 | |
| 5.60±0.05 | 3.3 | 1434 | 7.43 | 90 | 0.17 | 1687 | 8.75 | 61 | 0.17 | 1942 | 10.03 | 51 | 0.21 | 2199 | 10.42 | 37 | 0.22 | 2456 | 10.07 | 28 | 0.23 | |
| 6.2±0.1 | 3 | 1432 | 8.27 | 91 | 0.15 | 1686 | 10.21 | 60 | 0.15 | 1941 | 11.52 | 48 | 0.18 | 2198 | 11.88 | 36 | 0.18 | 2455 | 11.02 | 33 | 0.19 | |
| 6.8±0.1 | 2.8 | 1430 | 9.41 | 88 | 0.13 | 1684 | 11.43 | 58 | 0.13 | 1940 | 13.36 | 45 | 0.14 | 2196 | 13.72 | 37 | 0.14 | 2454 | 12.85 | 36 | 0.14 | |
| 7.5±0.1 | 2.7 | 1429 | 10.05 | 85 | 0.13 | 1683 | 12.25 | 56 | 0.14 | 1939 | 15.06 | 40 | 0.13 | 2195 | 15.24 | 35 | 0.15 | 2454 | 13.66 | 33 | 0.14 | |
| 8.2±0.1 | 2.6 | 1428 | 11.64 | 79 | 0.13 | 1682 | 14.43 | 52 | 0.13 | 1938 | 16.85 | 38 | 0.13 | 2195 | 16.65 | 32 | 0.14 | 2453 | 15.32 | 31 | 0.14 | |
| 9.1±0.1 | 2.5 | 1427 | 13.39 | 60 | 0.13 | 1681 | 19.07 | 33 | 0.14 | 1937 | 28.35 | 25 | 0.15 | 2194 | 31.08 | 15 | 0.16 | 2452 | 29.91 | 15 | 0.16 | |
| 10.0±1% | 2.4 | 1425 | 17.6 | 41 | 0.14 | 1680 | 26.51 | 21 | 0.16 | 1936 | 40.16 | 11 | 0.17 | 2194 | 45.46 | 8 | 0.18 | 2452 | 39.54 | 8 | 0.18 | |
| 11.0±1% | 2.3 | 1424 | 20.09 | 36 | 0.15 | 1679 | 32.66 | 19 | 0.15 | 1935 | 66.25 | 8 | 0.17 | 2192 | 81.07 | 5 | 0.2 | 2451 | 61.28 | 6 | 0.18 | |
| 12.0±1% | 2.2 | 1423 | 24.14 | 29 | 0.15 | 1678 | 43.51 | 13 | 0.14 | 1934 | 92.97 | 5 | 0.18 | 2192 | 123.19 | 3 | 0.2 | 2450 | 82.44 | 4 | 0.19 | |
| 13.0±1% | 2.2 | 1417 | 48.3 | 18 | 0.13 | 1671 | 63.2 | 5 | 0.17 | 1934 | 125 | 3 | 0.18 | 2191 | | | 0.2 | | | | | |
| 14.0±1% | 2.1 | 1422 | 39.55 | 17 | 0.15 | 1677 | 122 | 2 | 0.21 | 1934 | 180.3 | 1 | 0.19 | 2191 | | | 0.18 | | | | | |
| 15.0±1% | 2.1 | 1421 | 38.93 | 20 | 0.14 | 1676 | 154 | 2 | 0.17 | 1933 | 244.5 | | 0.16 | 2191 | | | 0.161 | | | | | |
| 16.0±1% | 2 | 1416 | 79.3 | 12 | 0.14 | 1670 | | | 0.17 | 1932 | | | 0.16 | 2191 | | | 0.16 | | | | | |
| 17.0±1% | 1.9 | 1415 | 77.6 | 11 | 0.14 | 1670 | | | 0.17 | 1932 | | | 0.16 | 2191 | | | 0.16 | | | | | |
| 18 | | | | | | | | | | | | | | | | | | | | | | |

Accu-F® / Accu-P®

0603 Typical Electrical Tables



1

| Capacitance & Tolerance* @ 1 MHz (pF) | Self Resonance Frequency (GHz) | Ref Freq. MHz | Effective Capacitance Max/Min (pF) | Max ESR (Ω) | Ref Freq. MHz | Effective Capacitance Max/Min (pF) | Max ESR (Ω) | Ref Freq. MHz | Effective Capacitance Max/Min (pF) | Max ESR (Ω) | Ref Freq. MHz | Effective Capacitance Max/Min (pF) | Max ESR (Ω) |
|---------------------------------------|--------------------------------|---------------|------------------------------------|-------------|---------------|------------------------------------|-------------|---------------|------------------------------------|-------------|---------------|------------------------------------|-------------|
| 0.1±0.05 | 18.0 | | N/A | N/A | N/A | N/A | N/A | N/A | N/A | N/A | N/A | N/A | N/A |
| 0.2±0.05 | 12.7 | | N/A | N/A | N/A | N/A | N/A | N/A | N/A | N/A | N/A | N/A | N/A |
| 0.3±0.05 | 10.4 | | N/A | N/A | N/A | N/A | N/A | N/A | N/A | N/A | N/A | N/A | N/A |
| 0.4±0.05 | 9.0 | | N/A | N/A | N/A | N/A | N/A | N/A | N/A | N/A | N/A | N/A | N/A |
| 0.5±0.05 | 8.1 | | N/A | N/A | N/A | N/A | N/A | N/A | N/A | N/A | N/A | N/A | N/A |
| 0.6±0.10 | 7.4 | | N/A | N/A | N/A | N/A | N/A | N/A | N/A | N/A | N/A | N/A | N/A |
| 0.7±0.10 | 6.8 | | N/A | N/A | N/A | N/A | N/A | N/A | N/A | N/A | N/A | N/A | N/A |
| 0.8±0.10 | 6.4 | | N/A | N/A | N/A | N/A | N/A | N/A | N/A | N/A | N/A | N/A | N/A |
| 0.9±0.10 | 6.0 | | N/A | N/A | N/A | N/A | N/A | N/A | N/A | N/A | N/A | N/A | N/A |
| 1.0±0.10 | 5.7 | 245 | 1.15/0.90 | .280 | 491 | 1.10/0.90 | .220 | 738 | 1.10/0.90 | .220 | 987 | 1.15/0.90 | .300 |
| 1.1±0.10 | 5.4 | 244 | 1.25/1.00 | .270 | 490 | 1.25/1.00 | .210 | 736 | 1.11/1.00 | .210 | 985 | 1.25/1.00 | .290 |
| 1.2±0.10 | 5.2 | 243 | 1.35/1.10 | .260 | 487 | 1.35/1.05 | .200 | 734 | 1.40/1.05 | .210 | 981 | 1.35/1.05 | .280 |
| 1.3±0.10 | 5.0 | 242 | 1.45/1.15 | .260 | 486 | 1.45/1.15 | .200 | 732 | 1.45/1.15 | .200 | 974 | 1.45/1.15 | .270 |
| 1.4±0.10 | 4.8 | 241 | 1.55/1.25 | .250 | 485 | 1.55/1.25 | .190 | 731 | 1.45/1.25 | .200 | 977 | 1.55/1.25 | .260 |
| 1.5±0.10 | 4.7 | 241 | 1.65/1.35 | .250 | 484 | 1.65/1.35 | .180 | 729 | 1.65/1.35 | .190 | 976 | 1.70/1.35 | .250 |
| 1.6±0.10 | 4.5 | 240 | 1.75/1.45 | .240 | 483 | 1.75/1.45 | .180 | 727 | 1.75/1.45 | .190 | 973 | 1.80/1.50 | .250 |
| 1.7±0.10 | 4.4 | 240 | 1.85/1.55 | .230 | 482 | 1.85/1.60 | .170 | 725 | 1.85/1.60 | .180 | 971 | 1.90/1.60 | .250 |
| 1.8±0.10 | 4.2 | 239 | 2.10/1.70 | .220 | 479 | 2.10/1.70 | .160 | 723 | 2.10/1.70 | .170 | 969 | 2.15/1.70 | .250 |
| 1.9±0.10 | 4.1 | 239 | 2.15/1.78 | .210 | 478 | 2.15/1.80 | .160 | 721 | 2.15/1.80 | .167 | 967 | 2.20/1.80 | .240 |
| 2.0±0.10 | 4.0 | 238 | 2.11/1.80 | .205 | 477 | 2.11/1.80 | .155 | 720 | 2.11/1.80 | .165 | 966 | 2.25/1.90 | .230 |
| 2.1±0.10 | 3.9 | 237 | 2.25/1.95 | .200 | 475 | 2.25/1.98 | .150 | 718 | 2.35/1.98 | .162 | 964 | 2.35/2.00 | .220 |
| 2.2±0.10 | 3.8 | 236 | 2.40/2.05 | .190 | 474 | 2.45/2.05 | .145 | 717 | 2.42/2.05 | .160 | 962 | 2.45/2.10 | .210 |
| 2.4±0.25 | 3.7 | 234 | 2.70/2.15 | .175 | 471 | 2.75/2.15 | .140 | 713 | 2.80/2.15 | .150 | 958 | 2.80/2.15 | .200 |
| 2.7±0.25 | 3.5 | 232 | 3.00/2.45 | .160 | 468 | 3.10/2.45 | .125 | 709 | 3.10/2.45 | .145 | 954 | 3.15/2.48 | .190 |
| 3.0±0.25 | 3.3 | 230 | 3.40/2.75 | .150 | 465 | 3.40/2.75 | .120 | 706 | 3.40/2.75 | .140 | 951 | 3.60/2.80 | .170 |
| 3.3±0.25 | 3.1 | 226 | 3.60/3.05 | .130 | 459 | 3.70/3.05 | .120 | 699 | 3.70/3.05 | .130 | 945 | 3.80/3.10 | .165 |
| 3.6±0.25 | 3.0 | 224 | 3.90/3.30 | .128 | 456 | 4.25/3.35 | .119 | 697 | 3.90/3.35 | .125 | 942 | 4.10/3.40 | .160 |
| 3.9±0.25 | 2.9 | 223 | 4.20/3.65 | .125 | 455 | 4.35/3.70 | .115 | 695 | 4.90/3.75 | .120 | 940 | 5.15/3.75 | .150 |
| 4.3±0.25 | 2.7 | 220 | 4.60/4.00 | .122 | 451 | 4.80/4.05 | .117 | 692 | 5.10/4.05 | .115 | 937 | 5.30/4.05 | .150 |
| 4.7±0.25 | 2.6 | 218 | 5.00/4.45 | .120 | 448 | 5.20/4.45 | .110 | 689 | 5.30/4.50 | .115 | 935 | 5.50/4.55 | .145 |
| 5.1±0.25 | 2.5 | 216 | 5.40/4.85 | .115 | 445 | 5.70/4.89 | .105 | 686 | 6.00/4.90 | .115 | 931 | 6.20/5.00 | .140 |
| 5.6±0.25 | 2.4 | 214 | 5.90/5.35 | .110 | 443 | 6.10/5.35 | .100 | 684 | 6.15/5.40 | .110 | 929 | 6.50/5.50 | .135 |
| 6.2±0.25 | 2.3 | 211 | 6.50/5.95 | .105 | 439 | 6.90/5.95 | .099 | 680 | 7.10/6.00 | .110 | 927 | 8.00/6.10 | .130 |
| 6.8±0.25 | 2.2 | 208 | 7.20/6.55 | .100 | 435 | 7.25/6.55 | .099 | 677 | 7.50/6.60 | .110 | 925 | 9.00/6.65 | .130 |
| 7.5±0.50 | 2.1 | 205 | 8.10/7.00 | .095 | 432 | 8.10/7.00 | .099 | 675 | 8.20/7.00 | .110 | 925 | 9.50/7.05 | .125 |
| 8.2±0.50 | 2.0 | 202 | 8.80/7.70 | .090 | 429 | 8.80/7.70 | .098 | 672 | 9.00/7.70 | .110 | 921 | 10.00/7.80 | .125 |
| 9.1±0.50 | 1.9 | 200 | 9.80/8.60 | .090 | 425 | 10.95/8.65 | .098 | 670 | 12.00/9.00 | .110 | 919 | 13.00/9.10 | .120 |
| 10±5% | 1.8 | 195 | 10.70/9.50 | .085 | 422 | 11.60/9.50 | .097 | 667 | 12.50/9.60 | .110 | 917 | 16.00/9.90 | .120 |
| 11±5% | 1.7 | 191 | 11.60/10.90 | .085 | 420 | 12.20/10.60 | .095 | 665 | 13.20/10.50 | .110 | 916 | 17.00/10.00 | .120 |
| 12±5% | 1.6 | 189 | 12.90/11.40 | .085 | 418 | 13.40/11.50 | .095 | 663 | 14.60/11.90 | .110 | 914 | 18.00/12.00 | .120 |
| 13±5% | 1.6 | 187 | 13.10/12.90 | .080 | 416 | 14.00/13.00 | .095 | 661 | 16.00/13.50 | .110 | 913 | 21.00/14.00 | .120 |
| 14±5% | 1.5 | 185 | 14.90/13.25 | .080 | 414 | 16.90/14.00 | .090 | 660 | 19.00/15.00 | .110 | 912 | 26.00/15.00 | .120 |
| 15±5% | 1.5 | 182 | 15.90/14.25 | .080 | 412 | 17.50/15.30 | .090 | 659 | 21.00/16.50 | .100 | 911 | 29.00/17.00 | .120 |
| 16±5% | 1.4 | 179 | 17.00/15.15 | .070 | 410 | 18.00/15.90 | .085 | 657 | 22.00/17.00 | .100 | 910 | 30.00/18.00 | .120 |
| 18±5% | 1.3 | 176 | 19.50/17.00 | .070 | 408 | 20.20/17.10 | .085 | 656 | 23.70/19.00 | .100 | 908 | 33.00/21.00 | .120 |
| 22±5% | 1.2 | 170 | 24.00/20.90 | .066 | 404 | 25.00/20.90 | .080 | 654 | 28.00/21.00 | .10 | 906 | 39.00/21.50 | .120 |
| 24±5% | 1.2 | 168 | 26.00/22.80 | .066 | 403 | 30.00/23.00 | .080 | 653 | N/A | .10 | 905 | N/A | .120 |
| 27±5% | 1.1 | 165 | 29.00/25.60 | .065 | 402 | 36.00/27.00 | .080 | 652 | N/A | .10 | 905 | N/A | .120 |
| 30±5% | 1.0 | 163 | 32.00/28.50 | .064 | 401 | 40.00/30.00 | .080 | 651 | N/A | .10 | 904 | N/A | .120 |
| 33±5% | 1.0 | 160 | 37.65/31.35 | .064 | 400 | 45.00/33.00 | .080 | 650 | N/A | .10 | 904 | N/A | .120 |

* Other tolerances are available, see page 8



Accu-F® / Accu-P®

0805 Typical Electrical Tables



1

| Capacitance & Tolerance* @ 1 MHz (pF) | Self Resonance Frequency (GHz) | Ref Freq. MHz | Effective Capacitance Max/Min (pF) | Max ESR (Ω) | Ref Freq. MHz | Effective Capacitance Max/Min (pF) | Max ESR (Ω) | Ref Freq. MHz | Effective Capacitance Max/Min (pF) | Max ESR (Ω) | Ref Freq. MHz | Effective Capacitance Max/Min (pF) | Max ESR (Ω) |
|---------------------------------------|--------------------------------|---------------|------------------------------------|-------------|---------------|------------------------------------|-------------|---------------|------------------------------------|-------------|---------------|------------------------------------|-------------|
| 0.1±0.05 | | | N/A | N/A | N/A | N/A | N/A | N/A | N/A | N/A | N/A | N/A | N/A |
| 0.2±0.05 | | | N/A | N/A | N/A | N/A | N/A | N/A | N/A | N/A | N/A | N/A | N/A |
| 0.3±0.05 | | | N/A | N/A | N/A | N/A | N/A | N/A | N/A | N/A | N/A | N/A | N/A |
| 0.4±0.05 | | | N/A | N/A | N/A | N/A | N/A | N/A | N/A | N/A | N/A | N/A | N/A |
| 0.5±0.05 | | | N/A | N/A | N/A | N/A | N/A | N/A | N/A | N/A | N/A | N/A | N/A |
| 0.6±0.10 | | | N/A | N/A | N/A | N/A | N/A | N/A | N/A | N/A | N/A | N/A | N/A |
| 0.7±0.10 | | | N/A | N/A | N/A | N/A | N/A | N/A | N/A | N/A | N/A | N/A | N/A |
| 0.8±0.10 | | | N/A | N/A | N/A | N/A | N/A | N/A | N/A | N/A | N/A | N/A | N/A |
| 0.9±0.10 | | | N/A | N/A | N/A | N/A | N/A | N/A | N/A | N/A | N/A | N/A | N/A |
| 1.0±0.10 | 5.6 | 250 | 1.20/0.90 | .320 | 500 | 1.20/0.90 | .300 | 750 | 1.20/0.90 | .270 | 999 | 1.20/0.90 | .300 |
| 1.1±0.10 | 5.4 | 248 | 1.30/1.00 | .290 | 496 | 1.30/1.00 | .270 | 754 | 1.30/1.00 | .250 | 993 | 1.30/1.00 | .290 |
| 1.2±0.10 | 5.1 | 245 | 1.40/1.10 | .270 | 492 | 1.40/1.10 | .250 | 739 | 1.40/1.10 | .240 | 987 | 1.40/1.10 | .280 |
| 1.3±0.10 | 4.9 | 243 | 1.50/1.20 | .260 | 488 | 1.50/1.20 | .230 | 734 | 1.50/1.10 | .230 | 980 | 1.50/1.10 | .270 |
| 1.4±0.10 | 4.8 | 242 | 1.60/1.30 | .240 | 487 | 1.60/1.20 | .220 | 733 | 1.60/1.20 | .220 | 979 | 1.60/1.30 | .260 |
| 1.5±0.10 | 4.6 | 242 | 1.70/1.40 | .230 | 486 | 1.70/1.40 | .210 | 731 | 1.70/1.40 | .220 | 977 | 1.70/1.40 | .260 |
| 1.6±0.10 | 4.5 | 241 | 1.80/1.50 | .220 | 484 | 1.85/1.50 | .210 | 729 | 2.00/1.50 | .220 | 975 | 2.00/1.50 | .250 |
| 1.7±0.10 | 4.3 | 240 | 1.90/1.60 | .210 | 483 | 1.95/1.60 | .200 | 728 | 2.05/1.60 | .210 | 974 | 2.20/1.60 | .240 |
| 1.8±0.10 | 4.2 | 239 | 2.00/1.70 | .200 | 482 | 2.05/1.70 | .190 | 726 | 2.10/1.70 | .210 | 972 | 2.30/1.70 | .230 |
| 1.9±0.10 | 4.1 | 239 | 2.10/1.80 | .200 | 481 | 2.15/1.80 | .190 | 724 | 2.25/1.80 | .200 | 970 | 2.40/1.80 | .230 |
| 2.0±0.10 | 4.0 | 238 | 2.20/1.90 | .190 | 479 | 2.30/1.90 | .180 | 722 | 2.40/1.90 | .200 | 967 | 2.60/1.95 | .220 |
| 2.1±0.10 | 3.9 | 237 | 2.30/2.00 | .190 | 477 | 2.40/2.00 | .170 | 720 | 2.60/2.00 | .190 | 964 | 2.80/2.06 | .210 |
| 2.2±0.10 | 3.8 | 236 | 2.40/2.10 | .180 | 475 | 2.60/2.10 | .170 | 716 | 2.80/2.14 | .190 | 962 | 3.06/2.17 | .210 |
| 2.4±0.25 | 3.6 | 235 | 2.85/2.15 | .170 | 473 | 3.13/2.29 | .170 | 714 | 3.17/2.30 | .190 | 960 | 3.31/2.31 | .210 |
| 2.7±0.25 | 3.4 | 233 | 3.19/2.45 | .160 | 470 | 3.47/2.55 | .150 | 711 | 3.52/2.60 | .170 | 957 | 3.67/2.60 | .200 |
| 3.0±0.25 | 3.3 | 231 | 3.51/2.75 | .150 | 465 | 3.76/2.86 | .140 | 707 | 3.84/2.93 | .160 | 952 | 4.00/3.00 | .190 |
| 3.3±0.25 | 3.1 | 229 | 3.83/3.05 | .140 | 463 | 4.04/3.10 | .140 | 704 | 4.15/3.19 | .160 | 948 | 4.38/3.30 | .190 |
| 3.6±0.25 | 3.0 | 228 | 4.16/3.35 | .140 | 462 | 4.35/3.42 | .130 | 704 | 4.50/3.53 | .150 | 947 | 4.80/3.60 | .190 |
| 3.9±0.25 | 2.9 | 227 | 4.48/3.65 | .130 | 459 | 4.67/3.72 | .120 | 701 | 4.85/3.86 | .150 | 944 | 5.23/3.90 | .180 |
| 4.3±0.25 | 2.7 | 223 | 4.91/4.05 | .130 | 456 | 5.11/4.13 | .120 | 697 | 5.32/4.25 | .150 | 940 | 5.79/4.50 | .180 |
| 4.7±0.25 | 2.6 | 220 | 5.35/4.45 | .120 | 451 | 5.52/4.53 | .110 | 691 | 5.79/4.60 | .140 | 936 | 6.36/4.80 | .170 |
| 5.1±0.25 | 2.5 | 218 | 5.78/4.85 | .120 | 447 | 5.94/4.94 | .110 | 688 | 6.25/5.20 | .140 | 934 | 7.16/5.74 | .160 |
| 5.6±0.25 | 2.4 | 215 | 6.00/5.35 | .100 | 444 | 6.82/5.40 | .100 | 684 | 7.27/5.60 | .120 | 930 | 8.25/5.90 | .150 |
| 6.2±0.25 | 2.3 | 212 | 7.00/5.95 | .100 | 442 | 7.52/6.00 | .100 | 683 | 8.08/6.10 | .120 | 927 | 9.35/6.80 | .150 |
| 6.8±0.25 | 2.2 | 208 | 7.20/6.55 | .100 | 435 | 8.21/6.88 | .100 | 677 | 8.90/6.96 | .120 | 925 | 10.46/7.32 | .150 |
| 7.5±0.05 | 2.1 | 206 | 8.64/7.00 | .100 | 434 | 9.02/7.10 | .100 | 675 | 9.85/7.50 | .120 | 924 | 11.75/8.42 | .150 |
| 8.2±0.05 | 2.0 | 203 | 9.40/7.70 | .090 | 432 | 9.83/7.90 | .080 | 673 | 10.80/8.25 | .110 | 922 | 13.04/9.53 | .150 |
| 9.1±0.05 | 1.9 | 199 | 10.37/8.60 | .080 | 429 | 10.88/8.76 | .080 | 670 | 12.02/9.10 | .110 | 920 | 14.70/10.70 | .150 |
| 10±5% | 1.8 | 196 | 11.00/9.50 | .080 | 423 | 11.92/9.76 | .080 | 668 | 13.24/10.00 | .110 | 918 | 15.37/11.80 | .140 |
| 11±5% | 1.8 | 193 | 12.50/10.45 | .080 | 420 | 13.23/10.50 | .080 | 665 | 15.07/11.00 | .110 | 916 | 16.00/12.20 | .140 |
| 12±5% | 1.6 | 190 | 13.61/11.40 | .070 | 418 | 14.50/11.90 | .080 | 663 | 16.90/12.82 | .110 | 915 | N/A | .140 |
| 13±5% | 1.6 | 187 | 14.75/12.35 | .070 | 416 | 15.80/13.00 | .080 | 662 | 18.87/14.00 | .110 | 914 | N/A | .140 |
| 14±5% | 1.5 | 184 | 15.88/13.30 | .070 | 414 | 17.22/14.00 | .080 | 661 | 20.84/16.00 | .110 | 913 | N/A | .140 |
| 15±5% | 1.5 | 182 | 17.02/14.25 | .070 | 414 | 18.56/15.19 | .080 | 660 | 22.62/19.13 | .110 | 912 | N/A | .130 |
| 16±5% | 1.4 | 179 | 18.16/15.20 | .070 | 411 | 19.90/16.28 | .080 | 659 | 27.00/20.89 | .100 | 911 | N/A | .130 |
| 18±5% | 1.3 | 176 | 20.42/17.10 | .070 | 408 | 22.69/18.57 | .070 | 657 | 33.00/22.10 | .100 | 910 | N/A | .130 |
| 20±5% | 1.3 | 173 | 22.70/19.00 | .060 | 406 | 25.38/20.78 | .070 | 656 | 38.00/23.15 | .100 | 908 | N/A | .130 |
| 22±5% | 1.2 | 171 | 24.95/20.90 | .060 | 405 | 28.08/21.00 | .070 | 655 | 42.00/24.00 | .100 | 907 | N/A | .130 |
| 24±5% | 1.2 | 168 | 27.20/22.80 | .060 | 403 | 31.31/25.61 | .070 | 654 | N/A | .090 | 907 | N/A | .130 |
| 27±5% | 1.1 | 165 | 30.78/25.69 | .060 | 401 | 36.10/32.20 | .070 | 652 | N/A | .090 | 906 | N/A | .130 |
| 30±5% | 1.0 | 163 | 34.23/28.50 | .050 | 400 | 40.58/33.20 | .070 | 651 | N/A | .090 | 905 | N/A | .130 |
| 33±5% | 1.0 | 159 | 37.85/31.35 | .050 | 399 | 46.65/35.00 | .070 | 650 | N/A | .090 | 904 | N/A | .120 |
| 36±5% | 0.9 | 157 | 41.19/34.20 | .050 | 397 | 52.22/38.00 | .070 | 649 | N/A | .090 | 903 | N/A | .120 |
| 39±5% | 0.9 | 155 | 44.79/37.05 | .050 | 396 | 59.08/47.08 | .070 | 648 | N/A | .090 | 902 | N/A | .120 |
| 43±5% | 0.9 | 153 | 49.99/40.85 | .050 | 395 | 70.50/53.04 | .060 | 647 | N/A | .090 | 901 | N/A | .120 |
| 47±5% | 0.8 | 152 | 55.19/44.65 | .050 | 394 | 81.99/59.00 | .060 | 646 | N/A | .090 | 900 | N/A | .110 |

* Other tolerances are available, see page 8



1210 Typical Electrical Tables

1

| Capacitance & Tolerance* @ 1 MHz (pF) | Self Resonance Frequency (GHz) | Ref Freq. (MHz) | Effective Capacitance Max/Min (pF) | Max ESR (Ω) | Ref Freq. (MHz) | Effective Capacitance Max/Min (pF) | Max ESR (Ω) | Ref Freq. (MHz) | Effective Capacitance Max/Min (pF) | Max ESR (Ω) | Ref Freq. (MHz) | Effective Capacitance Max/Min (pF) | Max ESR (Ω) |
|---------------------------------------|--------------------------------|-----------------|------------------------------------|-------------|-----------------|------------------------------------|-------------|-----------------|------------------------------------|-------------|-----------------|------------------------------------|-------------|
| 1.0±0.25 | 4.98 | 247 | 1.23/0.75 | .350 | 495 | 1.34/0.86 | .260 | 745 | 1.46/0.94 | .280 | 995 | 1.6/0.99 | .350 |
| 1.2±0.25 | 4.55 | 245 | 1.32/0.95 | .310 | 491 | 1.45/1.00 | .240 | 739 | 1.64/1.1 | .260 | 987 | 2.00/1.2 | .320 |
| 1.5±0.25 | 4.07 | 242 | 1.6/1.23 | .250 | 486 | 1.75/1.3 | .230 | 731 | 1.82/1.95 | .250 | 978 | 2.1/1.4 | .270 |
| 1.8±0.25 | 9.71 | 240 | 2.1/1.55 | .200 | 482 | 2.21/1.56 | .200 | 731 | 2.4/1.6 | .200 | 978 | 2.54/1.7 | .210 |
| 2.2±0.25 | 9.96 | 237 | 2.48/1.95 | .170 | 476 | 2.68/2.00 | .170 | 727 | 2.85/2.1 | .180 | 969 | 3.02/2.2 | .200 |
| 2.7±0.25 | 2.70 | 233 | 3.42/2.45 | .140 | 466 | 3.49/2.55 | .140 | 708 | 3.73/2.63 | .150 | 952 | 3.89/2.70 | .170 |
| 3.3±0.25 | 2.60 | 229 | 4.02/3.05 | .140 | 463 | 4.09/3.15 | .130 | 704 | 4.33/3.23 | .140 | 948 | 4.49/3.30 | .160 |
| 3.6±0.25 | 2.50 | 228 | 4.18/3.35 | .130 | 462 | 4.32/3.43 | .130 | 704 | 4.50/3.32 | .140 | 947 | 4.78/3.45 | .160 |
| 3.9±0.25 | 2.40 | 227 | 4.53/3.65 | .130 | 458 | 4.66/3.73 | .120 | 701 | 4.85/3.75 | .140 | 944 | 5.18/3.90 | .150 |
| 4.3±0.25 | 2.30 | 223 | 5.01/4.05 | .120 | 456 | 5.11/4.14 | .110 | 697 | 5.32/4.29 | .130 | 940 | 5.72/4.30 | .140 |
| 4.7±0.25 | 2.20 | 220 | 5.48/4.45 | .120 | 451 | 5.62/4.50 | .110 | 691 | 5.94/4.60 | .130 | 936 | 6.56/4.70 | .140 |
| 5.1±0.25 | 2.10 | 218 | 5.88/4.85 | .110 | 447 | 6.04/4.90 | .110 | 683 | 6.36/5.10 | .130 | 933 | 7.20/5.40 | .140 |
| 5.6±0.25 | 2.00 | 215 | 6.49/5.35 | .110 | 441 | 6.72/5.56 | .100 | 681 | 7.17/5.67 | .120 | 928 | 8.15/6.00 | .140 |
| 6.2±0.25 | 1.90 | 212 | 7.19/5.95 | .100 | 442 | 7.26/6.07 | .100 | 679 | 7.99/6.10 | .110 | 927 | 9.18/7.00 | .130 |
| 6.8±0.25 | 1.80 | 208 | 7.38/6.55 | .100 | 435 | 8.16/6.42 | .100 | 677 | 8.81/6.93 | .110 | 925 | 10.20/7.42 | .130 |
| 7.5±0.25 | 1.70 | 206 | 8.60/7.90 | .100 | 434 | 8.90/7.25 | .100 | 675 | 9.58/7.60 | .100 | 924 | 11.36/8.00 | .130 |
| 8.2±0.25 | 1.70 | 203 | 9.36/7.70 | .100 | 432 | 9.76/7.96 | .090 | 673 | 10.68/8.31 | .100 | 922 | 13.00/9.10 | .130 |
| 9.1±0.25 | 1.60 | 199 | 10.34/8.60 | .090 | 429 | 10.87/8.88 | .090 | 670 | 12.10/9.66 | .090 | 920 | 15.11/10.25 | .130 |
| 10±5% | 1.50 | 196 | 11.33/9.50 | .090 | 423 | 11.97/9.79 | .090 | 668 | 13.51/10.05 | .090 | 918 | 17.22/11.06 | .130 |
| 11±5% | 1.50 | 193 | 12.50/10.45 | .090 | 420 | 13.23/10.83 | .090 | 665 | 15.07/11.33 | .090 | 916 | N/A | .130 |
| 12±5% | 1.40 | 190 | 13.61/11.40 | .080 | 418 | 14.59/11.90 | .080 | 663 | 16.90/12.82 | .090 | 915 | N/A | .120 |
| 13±5% | 1.30 | 185 | 14.75/12.35 | .080 | 416 | 15.64/13.00 | .080 | 662 | 18.80/13.60 | .090 | 914 | N/A | .120 |
| 14±5% | 1.30 | 183 | 15.89/13.30 | .080 | 415 | 17.22/14.00 | .080 | 661 | 20.85/16.00 | .090 | 913 | N/A | .120 |
| 15±5% | 1.20 | 182 | 17.02/14.25 | .080 | 414 | 18.56/15.19 | .080 | 660 | 22.62/17.00 | .090 | 912 | N/A | .110 |
| 16±5% | 1.20 | 180 | 18.16/15.20 | .080 | 411 | 19.90/16.28 | .080 | 659 | 25.12/18.00 | .090 | 911 | N/A | .110 |
| 18±5% | 1.10 | 176 | 20.42/17.10 | .070 | 408 | 22.69/18.57 | .080 | 657 | 30.00/24.00 | .080 | 909 | N/A | .110 |
| 20±5% | 1.10 | 173 | 22.70/19.00 | .070 | 406 | 25.36/20.78 | .080 | 656 | 35.00/26.00 | .080 | 908 | N/A | .110 |
| 22±5% | 1.00 | 171 | 24.95/20.90 | .070 | 405 | 28.06/22.96 | .080 | 655 | 42.00/27.00 | .080 | 908 | N/A | .110 |
| 24±5% | 0.98 | 168 | 27.20/22.60 | .070 | 403 | 31.31/25.60 | .080 | 654 | N/A | .080 | 907 | N/A | .110 |
| 25±5% | 0.96 | 166 | 26.39/23.75 | .070 | 402 | 32.91/26.00 | .080 | 653 | N/A | .080 | 907 | N/A | .110 |
| 27±5% | 0.92 | 164 | 30.78/25.65 | .070 | 401 | 36.10/28.00 | .070 | 652 | N/A | .080 | 906 | N/A | .110 |
| 28±5% | 0.91 | 163 | 31.93/26.50 | .070 | 401 | 37.60/30.76 | .070 | 651 | N/A | .080 | 906 | N/A | .110 |
| 30±5% | 0.88 | 162 | 34.23/28.50 | .070 | 400 | 40.50/33.20 | .070 | 651 | N/A | .080 | 905 | N/A | .110 |
| 32±5% | 0.85 | 161 | 36.51/30.40 | .070 | 399 | 44.63/34.50 | .070 | 650 | N/A | .080 | 905 | N/A | .110 |
| 33±5% | 0.84 | 159 | 37.65/31.35 | .060 | 399 | 46.65/35.00 | .070 | 650 | N/A | .080 | 905 | N/A | .110 |
| 34±5% | 0.82 | 158 | 38.83/32.30 | .060 | 398 | 48.51/37.00 | .070 | 649 | N/A | .080 | 904 | N/A | .110 |
| 36±5% | 0.80 | 157 | 41.20/34.20 | .060 | 397 | 52.22/41.00 | .070 | 649 | N/A | .070 | 904 | N/A | .110 |
| 39±5% | 0.77 | 155 | 44.79/37.05 | .060 | 396 | 59.00/43.00 | .070 | 649 | N/A | .070 | 904 | N/A | .110 |
| 43±5% | 0.73 | 153 | 49.99/40.85 | .060 | 396 | 70.00/46.00 | .070 | 648 | N/A | .070 | 904 | N/A | .110 |
| 47±5% | 0.70 | 152 | 55.69/44.65 | .060 | 395 | 81.00/53.00 | .070 | 648 | N/A | .070 | 903 | N/A | .110 |

* Other tolerances are available, see page 8

Typical ESR vs. Frequency
Accu-P[®] 0201

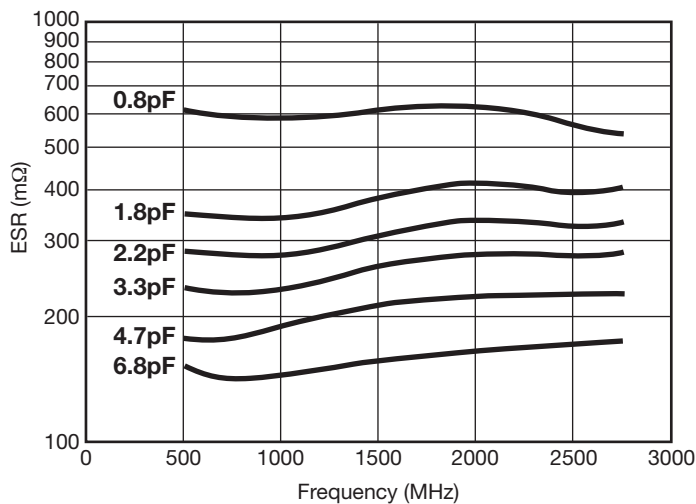

Typical SRF vs. Capacitance
Accu-P[®] 0201

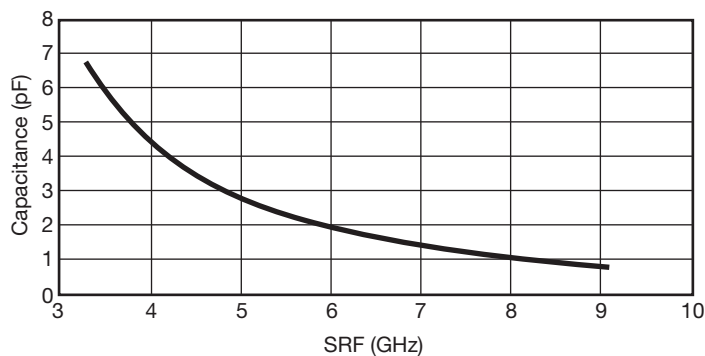

Typical Q vs. Frequency
Accu-P[®] 0201

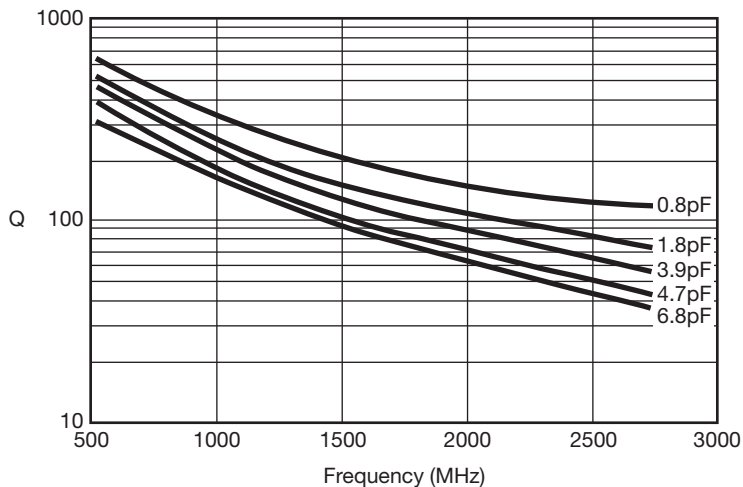

Accu-F® / Accu-P®

High Frequency Characteristics



1

Typical ESR vs. Frequency
Accu-P® 0402

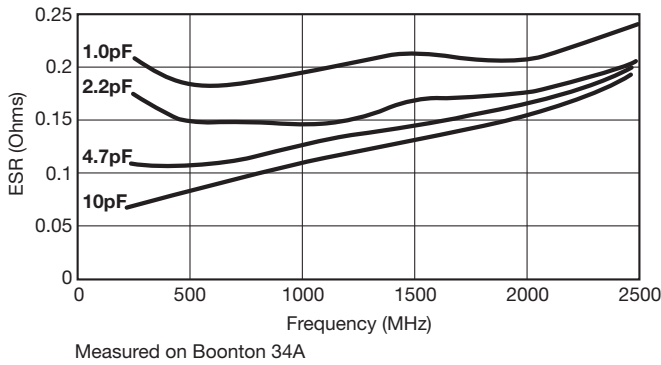

Typical ESR vs. Frequency
Accu-F®/Accu-P® 0603

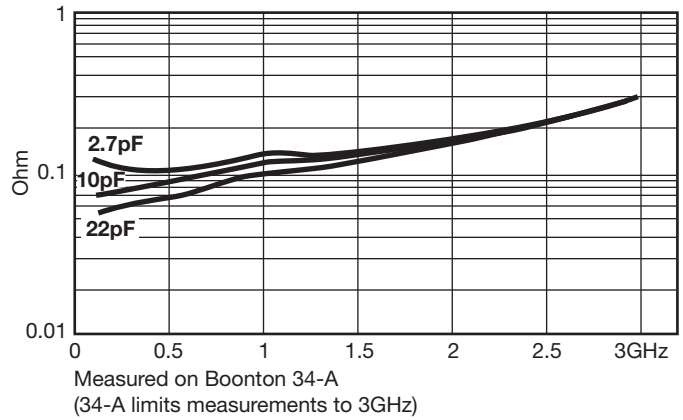

Typical Q vs. Frequency
Accu-P® 0402

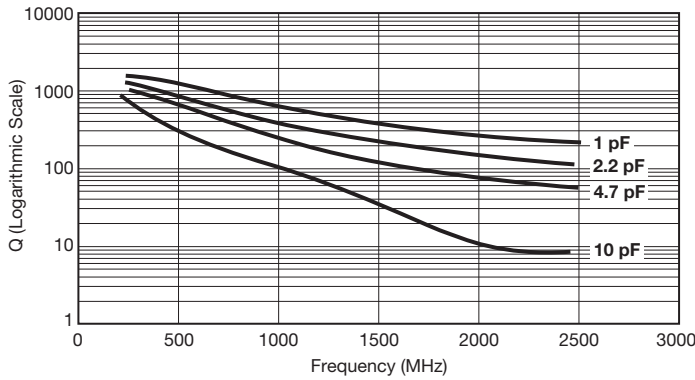

Typical Q vs. Frequency
Accu-F®/Accu-P® 0603

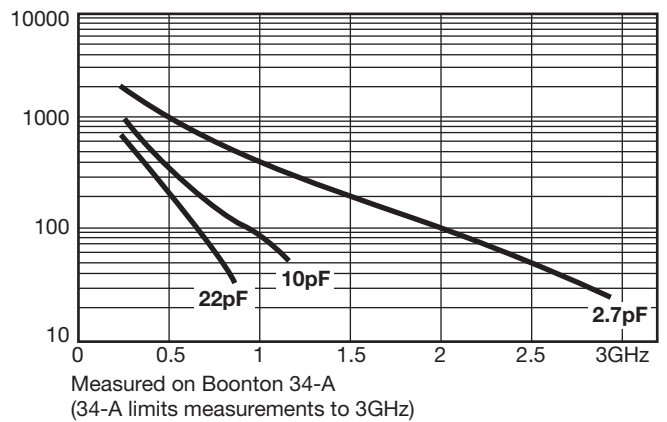

Typical Self Resonant Frequency vs. Capacitance
Accu-P® 0402

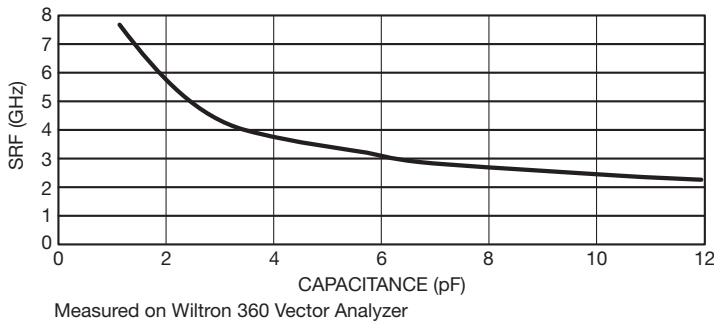

Typical Self Resonant Frequency vs. Capacitance
Accu-F®/Accu-P® 0603

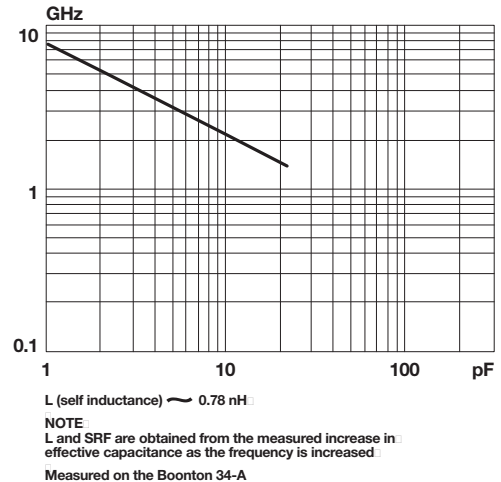

Accu-F® / Accu-P®

High Frequency Characteristics



1

Typical ESR vs. Frequency
Accu-F®/Accu-P® 0805

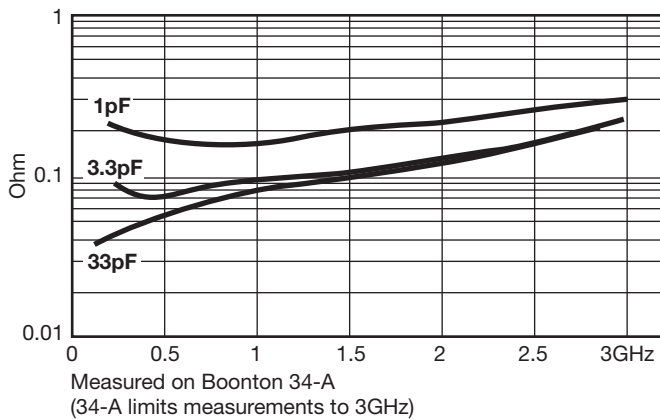

Typical ESR vs. Frequency
Accu-P® 1210

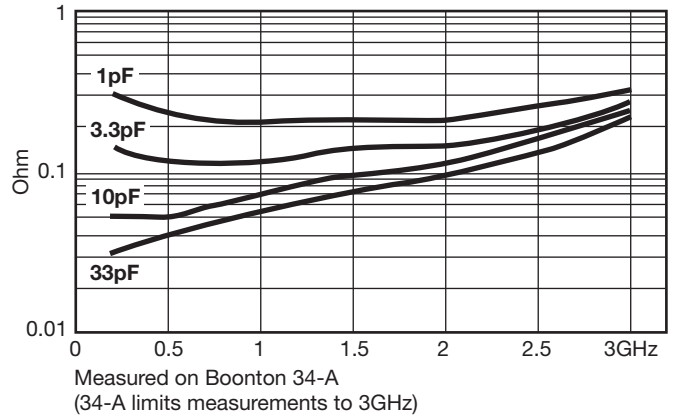

Typical Q vs. Frequency
Accu-F®/Accu-P® 0805

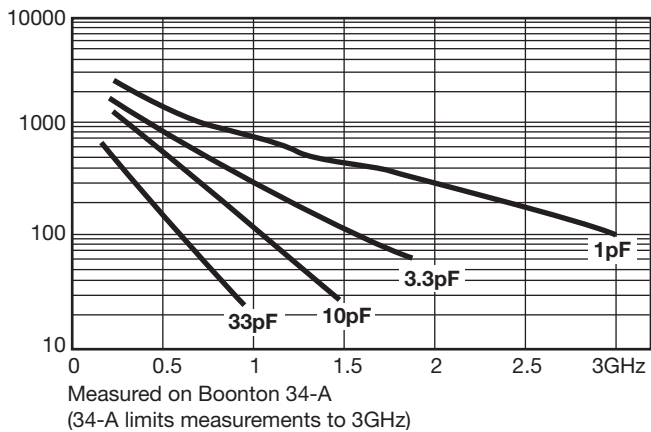

Typical Q vs. Frequency
Accu-P® 1210

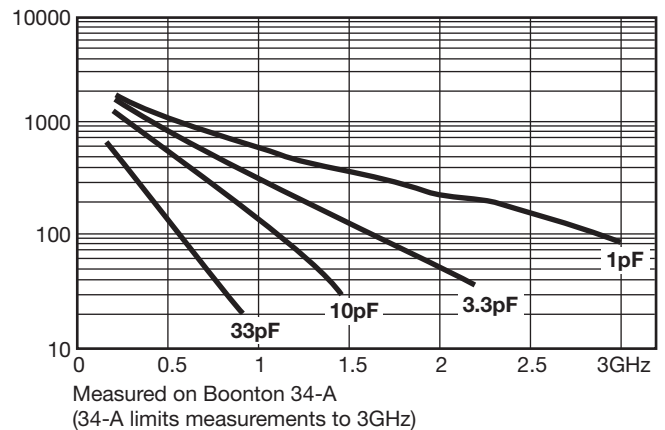

Typical Self Resonant Frequency vs. Capacitance
Accu-F®/Accu-P® 0805

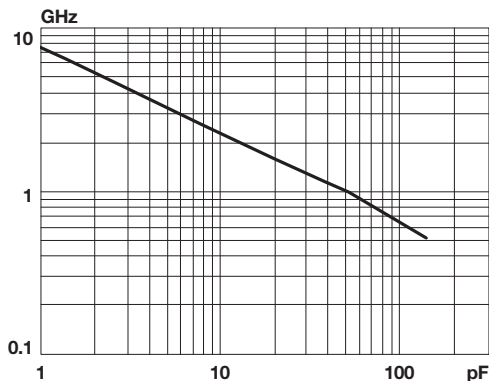

L (self inductance) ~ 0.82 nH
NOTE
L and SRF are obtained from the measured increase in effective capacitance as the frequency is increased
Measured on the Boonton 34-A

Typical Self Resonant Frequency vs. Capacitance
Accu-P® 1210

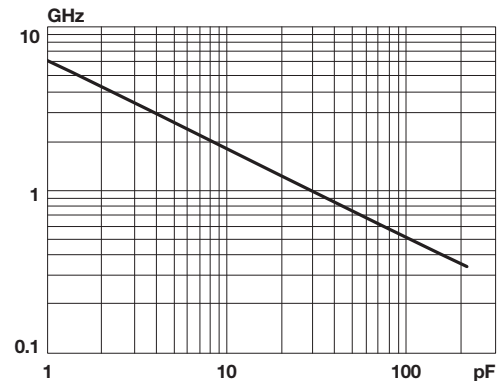

L (self inductance) ~ 1.02 nH
NOTE
L and SRF are obtained from the measured increase in effective capacitance as the frequency is increased
Measured on the Boonton 34-A

ENVIRONMENTAL CHARACTERISTICS

| TEST | CONDITIONS | REQUIREMENT |
|--|---|--|
| Life (Endurance) MIL-STD-202F Method 108A | 125°C, 2U _R , 1000 hours | No visible damage $\Delta C/C \leq 2\%$ for $C \geq 5\text{pF}$ $\Delta C \leq 0.25\text{pF}$ for $C < 5\text{pF}$ |
| Accelerated Damp Heat Steady State MIL-STD-202F Method 103B | 85°C, 85% RH, U _R , 1000 hours | No visible damage $\Delta C/C \leq 2\%$ for $C \geq 5\text{pF}$ $\Delta C \leq 0.25\text{pF}$ for $C < 5\text{pF}$ |
| Temperature Cycling MIL-STD-202F Method 107E MIL-STD-883D Method 1010.7 | -55°C to +125°C, 15 cycles – Accu-P® -55°C to +125°C, 5 cycles – Accu-F® | No visible damage $\Delta C/C \leq 2\%$ for $C \geq 5\text{pF}$ $\Delta C \leq 0.25\text{pF}$ for $C < 5\text{pF}$ |
| Resistance to Solder Heat IEC-68-2-58 | 260°C ± 5°C for 10 secs | C remains within initial limits |

MECHANICAL CHARACTERISTICS

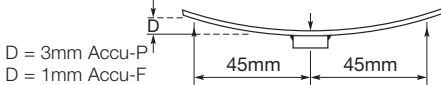
| TEST | CONDITIONS | REQUIREMENT |
|--|--|--|
| Solderability IEC-68-2-58 | Components completely immersed in a solder bath at 235°C for 2 secs. | Terminations to be well tinned, minimum 95% coverage |
| Leach Resistance IEC-68-2-58 | Components completely immersed in a solder bath at 260±5°C for 60 secs. | Dissolution of termination faces ≤15% of area Dissolution of termination edges ≤25% of length |
| Adhesion MIL-STD-202F Method 211A | A force of 5N applied for 10 secs. | No visible damage |
| Termination Bond Strength IEC-68-2-21 Amend. 2 | Tested as shown in diagram  D = 3mm Accu-P D = 1mm Accu-F | No visible damage $\Delta C/C \leq 2\%$ for $C \geq 5\text{pF}$ $\Delta C \leq 0.25\text{pF}$ for $C < 5\text{pF}$ |
| Robustness of Termination IEC-68-2-21 Amend. 2 | A force of 5N applied for 10 secs. | No visible damage |
| High Frequency Vibration MIL-STD-202F Method 201A, 204D (Accu-P® only) | 55Hz to 2000Hz, 20G | No visible damage |
| Storage | 12 months minimum with components stored in “as received” packaging | Good solderability |

QUALITY & RELIABILITY

Accu-P® is based on well established thin-film technology and materials.

• ON-LINE PROCESS CONTROL

This program forms an integral part of the production cycle and acts as a feedback system to regulate and control production processes. The test procedures, which are integrated into the production process, were developed after long research work and are based on the highly developed semiconductor industry test procedures and equipment. These measures help AVX to produce a consistent and high yield line of products.

• FINAL QUALITY INSPECTION

Finished parts are tested for standard electrical parameters and visual/mechanical characteristics. Each production lot is 100% evaluated for: capacitance and proof voltage at 2.5 U_R. In addition, production is periodically evaluated for:

Average capacitance with histogram printout for capacitance distribution;
IR and Breakdown Voltage distribution;
Temperature Coefficient;
Solderability;
Dimensional, mechanical and temperature stability.

QUALITY ASSURANCE

The reliability of these thin-film chip capacitors has been studied intensively for several years. Various measures have been taken to obtain the high reliability required today by the industry. Quality assurance policy is based on well established international industry standards. The reliability of the capacitors is determined by accelerated testing under the following conditions:

| | |
|------------------------------------|--|
| Life (Endurance) | 125°C, 2U _R , 1000 hours |
| Accelerated Damp Heat Steady State | 85°C, 85% RH, U _R , 1000 hours. |

Performance Characteristics RF Power Applications

RF POWER APPLICATIONS

In RF power applications capacitor losses generate heat. Two factors of particular importance to designers are:

- Minimizing the generation of heat.
- Dissipating heat as efficiently as possible.

CAPACITOR HEATING

- The major source of heat generation in a capacitor in RF power applications is a function of RF current (I) and ESR, from the relationship:

$$\text{Power dissipation} = I_{\text{RMS}}^2 \times \text{ESR}$$

- Accu-P® capacitors are specially designed to minimize

ESR and therefore RF heating. Values of ESR for Accu-P® capacitors are significantly less than those of ceramic MLC components currently available.

HEAT DISSIPATION

- Heat is dissipated from a capacitor through a variety of paths, but the key factor in the removal of heat is the thermal conductivity of the capacitor material.
- The higher the thermal conductivity of the capacitor, the more rapidly heat will be dissipated.
- The table below illustrates the importance of thermal conductivity to the performance of Accu-P® in power applications.



| PRODUCT | MATERIAL | THERMAL CONDUCTIVITY W/mK |
|---------------|--------------------|---------------------------|
| Accu-P® | Alumina | 18.9 |
| Microwave MLC | Magnesium Titanate | 6.0 |

**Power Handling
Accu-P® 10pF**

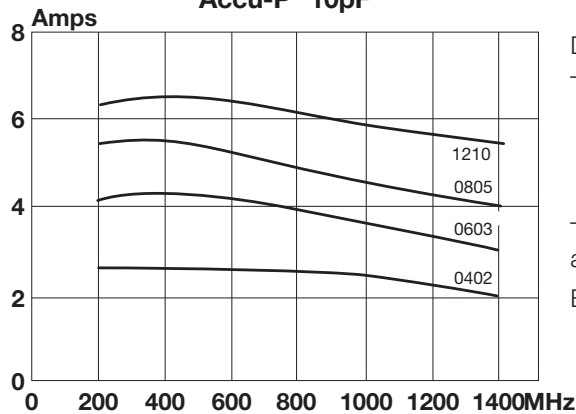

Data used in calculating the graph:

Thermal impedance of capacitors:

| | |
|------|---------|
| 0402 | 17°C/W |
| 0603 | 12°C/W |
| 0805 | 6.5°C/W |
| 1210 | 5°C/W |

Thermal impedance measured using RF generator, amplifier and strip-line transformer.

ESR of capacitors measured on Boonton 34A

THERMAL IMPEDANCE

Thermal impedance of Accu-P® chips is shown below compared with the thermal impedance of Microwave MLC's.

| CAPACITOR TYPE | CHIP SIZE | THERMAL IMPEDANCE (°C/W) |
|----------------|-----------|--------------------------|
| Accu-P® | 0805 | 6.5 |
| | 1210 | 5 |
| Microwave MLC | 0505 | 12 |
| | 1210 | 7.5 |

The thermal impedance expresses the temperature difference in °C between chip center and termination caused by a power dissipation of 1 watt in the chip. It is expressed in °C/W.

ADVANTAGES OF ACCU-P® IN RF POWER CIRCUITS

The optimized design of Accu-P® offers the designer of RF power circuits the following advantages:

- Reduced power losses due to the inherently low ESR of Accu-P®.
- Increased power dissipation due to the high thermal conductivity of Accu-P®.

• THE ONLY TRUE TEST OF A CAPACITOR IN ANY PARTICULAR APPLICATION IS ITS PERFORMANCE UNDER OPERATING CONDITIONS IN THE ACTUAL CIRCUIT.

PRACTICAL APPLICATION IN RF POWER CIRCUITS

- There is a wide variety of different experimental methods for measuring the power handling performance of a capacitor in RF power circuits. Each method has its own problems and few of them exactly reproduce the conditions present in "real" circuit applications.
- Similarly, there is a very wide range of different circuit applications, all with their unique characteristics and operating conditions which cannot possibly be covered by such "theoretical" testing.

Application Notes

GENERAL

Accu-F® and Accu-P® SMD capacitors are designed for soldering to printed circuit boards or other substrates. The construction of the components is such that they will withstand the time/temperature profiles used in both wave and reflow soldering methods.

1

CIRCUIT BOARD TYPE

The circuit board types which may be used with Accu-F® and Accu-P® are as follows:

Accu-F®: All flexible types of circuit boards (eg. FR-4, G-10).

Accu-P®: All flexible types of circuit boards (eg. FR-4, G-10) and also alumina.

For other circuit board materials, please consult factory.

HANDLING

SMD capacitors should be handled with care to avoid damage or contamination from perspiration and skin oils. The use of plastic tipped tweezers or vacuum pick-ups is strongly recommended for individual components. Bulk handling should ensure that abrasion and mechanical shock are minimized. For automatic equipment, taped and reeled product gives the ideal medium for direct presentation to the placement machine.

COMPONENT PAD DESIGN

Component pads must be designed to achieve good joints and minimize component movement during reflow soldering. Pad designs are given below for both wave and reflow soldering.

The basis of these designs is:

- Pad width equal to component width. It is permissible to decrease this to as low as 85% of component width but it is not advisable to go below this.
- Pad overlap 0.5mm beneath large components. Pad overlap about 0.3mm beneath small components.
- Pad extension of 0.5mm for reflow of large components and pad extension about 0.3mm for reflow of small components. Pad extension about 1.0mm for wave soldering.

WAVE SOLDERING

DIMENSIONS: millimeters (inches)

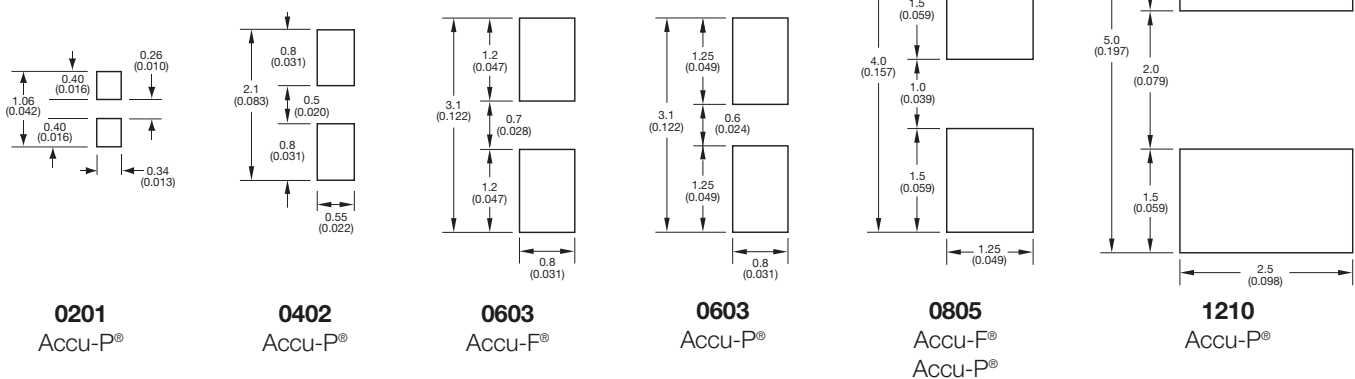

REFLOW SOLDERING

DIMENSIONS: millimeters (inches)

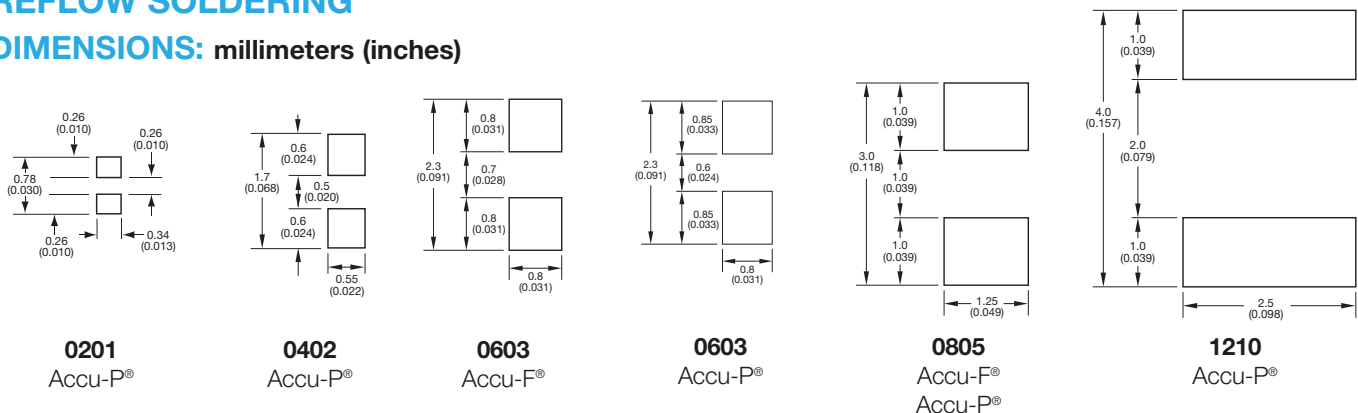

Application Notes

PREHEAT & SOLDERING

The rate of preheat in production should not exceed 4°C/second and a recommended maximum is about 2°C/second. Temperature differential from preheat to soldering should not exceed 100°C.

For further specific application or process advice, please consult AVX.

COOLING

After soldering, the assembly should preferably be allowed to cool naturally. In the event of assisted cooling, similar conditions to those recommended for preheating should be used.

HAND SOLDERING & REWORK

Hand soldering is permissible. Preheat of the PCB to 150°C is required. The most preferable technique is to use hot air soldering tools. Where a soldering iron is used, a temperature controlled model not exceeding 30 watts should be used and set to not more than 260°C.

RECOMMENDED SOLDERING PROFILE

IR REFLOW

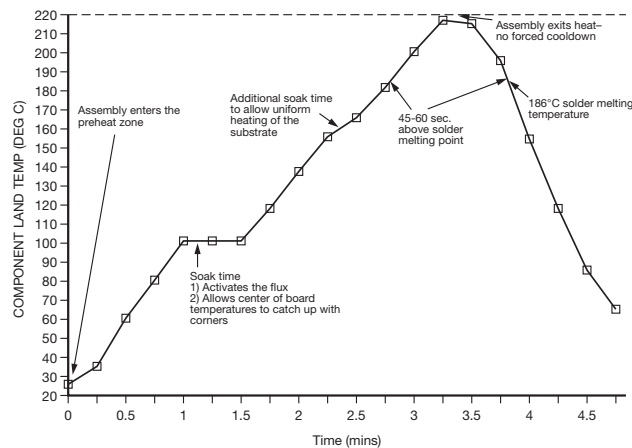

VAPOR PHASE

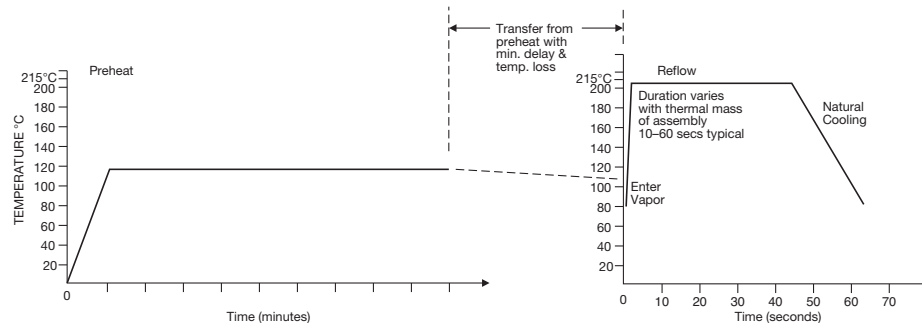

CLEANING RECOMMENDATIONS

Care should be taken to ensure that the devices are thoroughly cleaned of flux residues, especially the space beneath the device. Such residues may otherwise become conductive and effectively offer a lossy bypass to the device. Various recommended cleaning conditions (which must be optimized for the flux system being used) are as follows:

- Cleaning liquids. i-propanol, ethanol, acetylacetone, water and other standard PCB cleaning liquids.
- Ultrasonic conditions . . power-20w/liter max. frequency-20kHz to 45kHz.
- Temperature 80°C maximum (if not otherwise limited by chosen solvent system).
- Time 5 minutes max.

STORAGE CONDITIONS

Recommended storage conditions for Accu-F® and Accu-P® prior to use are as follows:

- Temperature 15°C to 35°C
- Humidity ≤65%
- Air Pressure 860mbar to 1060mbar

WAVE SOLDERING

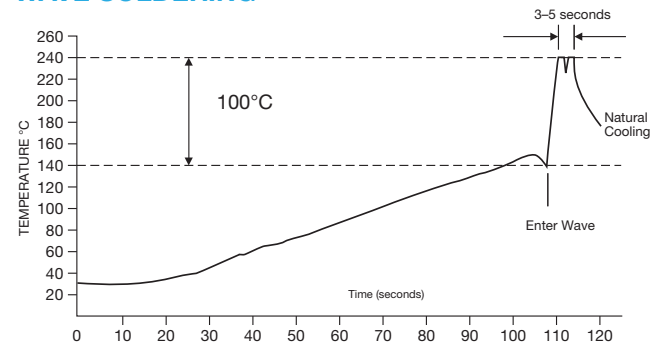

Automatic Insertion Packaging

TAPE & REEL

All tape and reel specifications are in compliance with EIA 481-1-A.
(equivalent to IEC 286 part 3).

- 8mm carrier
- Reeled quantities: Reels of 3,000 per 7" reel or 10,000 pieces per 13" reel
0201 and 0402 = 5,000 pieces per 7" reel and 20,000 pieces per 13" reel

1

REEL

DIMENSIONS: millimeters (inches)

| A ⁽¹⁾ | B | C | D | E | F | G |
|--------------------------|--------------------------|---------------------------|---------------------------|-------------------------|----------------------------|---------------------------|
| 180±1.0 (7.087±0.039) | 1.5 min. (0.059 min.) | 13±0.2 (0.512 ± 0.008) | 20.2 min. (0.795 min.) | 50 min. (1.969 min.) | 9.6±1.5 (0.370 ± 0.050) | 14.4 max. (0.567 max.) |

Metric dimensions will govern.
Inch measurements rounded and for reference only.

(1) 330mm (13 inch) reels are available.

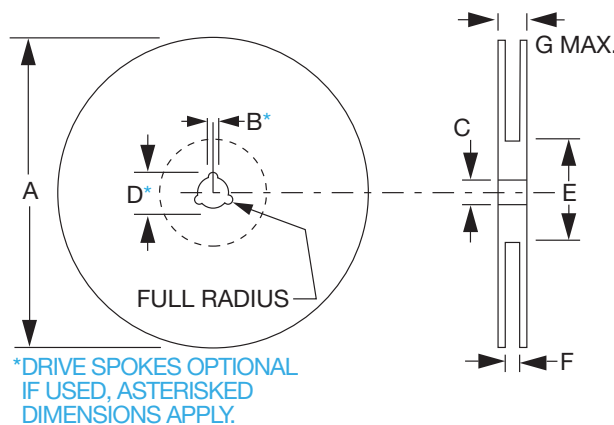

CARRIER

DIMENSIONS: millimeters (inches)

| A | B | C | D | E | F |
|------------------------------|-------------------------------|-----------------------------|-------------------------------|------------------------------|---|
| 8.0 ± 0.3 (0.315 ± 0.012) | 3.5 ± 0.05 (0.138 ± 0.002) | 1.75±0.1 (0.069 ± 0.004) | 2.0 ± 0.05 (0.079 ± 0.002) | 4.0 ± 0.1 (0.157 ± 0.004) | 1.5 ^{+0.1} _{-0.0} (0.059 ^{+0.004} _{-0.000}) |

NOTE: The nominal dimensions of the component compartment (W,L) are derived from the component size.

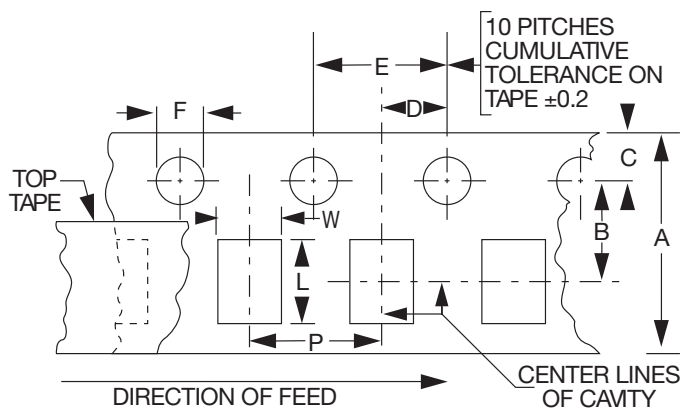

P = 4mm except 0201 and 0402 where P = 2mm

NOTE: AVX reserves the right to change the information published herein without notice.