



# Thin-Film Technology

Accu-F<sup>®</sup> / Accu-P<sup>®</sup>

Thin-Film RF/Microwave Capacitors

## Thin-Film Technology

### THE IDEAL CAPACITOR

The non-ideal characteristics of a real capacitor can be ignored at low frequencies. Physical size imparts inductance to the capacitor and dielectric and metal electrodes result in resistive losses, but these often are of negligible effect on the circuit. At the very high frequencies of radio communication (>100MHz) and satellite systems (>1GHz), these effects become important. Recognizing that a real capacitor will exhibit inductive and resistive impedances in addition to capacitance, the ideal capacitor for these high frequencies is an ultra low loss component which can be fully characterized in all parameters with total repeatability from unit to unit.

Until recently, most high frequency/microwave capacitors were based on fired-ceramic (porcelain) technology. Layers of ceramic dielectric material and metal alloy electrode paste are interleaved and then sintered in a high temperature oven. This technology exhibits component variability in dielectric quality (losses, dielectric constant and insulation resistance), variability in electrode conductivity and variability in physical size (affecting inductance). An alternate thin-film technology has been developed which virtually eliminates these variances. It is this technology which has been fully incorporated into Accu-F® and Accu-P® to provide high frequency capacitors exhibiting truly ideal characteristics.

The main features of Accu-F® and Accu-P® may be summarized as follows:

- High purity of electrodes for very low and repeatable ESR.
- Highly pure, low-K dielectric for high breakdown field, high insulation resistance and low losses to frequencies above 40GHz.
- Very tight dimensional control for uniform inductance, unit to unit.
- Very tight capacitance tolerances for high frequency signal applications.

This accuracy sets apart these Thin-Film capacitors from ceramic capacitors so that the term Accu has been employed as the designation for this series of devices, an abbreviation for “accurate.”

### THIN-FILM TECHNOLOGY

Thin-film technology is commonly used in producing semiconductor devices. In the last two decades, this technology has developed tremendously, both in performance and in process control. Today’s techniques enable line definitions of below 1µm, and the controlling of thickness of layers at 100Å (10<sup>-2</sup>µm). Applying this technology to the manufacture of capacitors has enabled the development of components where both electrical and physical properties can be tightly controlled.

The thin-film production facilities at AVX consist of:

- Class 1000 clean rooms, with working areas under laminar-flow hoods of class 100, (below 100 particles per cubic foot larger than 0.5µm).
- High vacuum metal deposition systems for high-purity electrode construction.
- Photolithography equipment for line definition down to 2.0µm accuracy.
- Plasma-enhanced CVD for various dielectric depositions (CVD=Chemical Vapor Deposition).
- High accuracy, microprocessor-controlled dicing saws for chip separation.
- High speed, high accuracy sorting to ensure strict tolerance adherence.



## Thin-Film Chip Capacitors

### ACCU-F® TECHNOLOGY

The use of very low-loss dielectric materials, silicon dioxide and silicon oxynitride, in conjunction with highly conductive electrode metals results in low ESR and high Q. These high-frequency characteristics change at a slower rate with increasing frequency than for ceramic microwave capacitors.

Because of the thin-film technology, the above-mentioned frequency characteristics are obtained without significant compromise of properties required for surface mounting.

The main Accu-F® properties are:

- Internationally agreed sizes with excellent dimensional control.
- Small size chip capacitors (0603) are available.
- Tight capacitance tolerances.
- Low ESR at VHF, UHF and microwave frequencies.
- High stability with respect to time, temperature, frequency and voltage variation.
- Nickel/solder-coated terminations to provide excellent solderability and leach resistance.

### ACCU-F® FEATURES

Accu-F® meets the fast-growing demand for low-loss (high-Q) capacitors for use in surface mount technology especially for the mobile communications market, such as cellular radio of 450 and 900 MHz, UHF walkie-talkies, UHF cordless telephones to 2.3 GHz, low noise blocks at 11-12.5 GHz and for other VHF, UHF and microwave applications.

Accu-F® is currently unique in its ability to offer very low capacitance values (0.1pF) and very tight capacitance tolerances ( $\pm 0.05\text{pF}$ ). Typically Accu-F® will be used in small signal applications in VCO's, matching networks, filters, etc.

Inspection test and quality control procedures in accordance with ISO 9001, CECC, IECQ and USA MIL Standards yield products of the highest quality.

### APPLICATIONS

- |  |                     |
|--|---------------------|
| Cellular Communications                              | Radar Systems       |
| CT2/PCN (Cordless Telephone/Personal Comm. Networks) | Video Switching     |
| Satellite TV   | Test & Measurements |
| Cable TV   | Filters             |
| GPS (Global Positioning Systems)                     | VCO's               |
| Vehicle Location Systems                             | Matching Networks   |
| Vehicle Alarm Systems                                |                     |
| Paging   |                     |
| Military Communications                              |                     |

### APPROVALS

ISO 9001

### ACCU-P® TECHNOLOGY

As in the Accu-F® series the use of very low-loss dielectric materials (silicon dioxide and silicon oxynitride) in conjunction with highly conductive electrode metals results in low ESR and high Q. At high frequency these characteristics change at a slower rate with increasing frequency than conventional ceramic microwave capacitors. Using thin-film technology, the above-mentioned frequency characteristics are obtained without significant compromise of properties required for surface mounting. The use of high thermal conductivity materials results in excellent RF power handling capabilities.

The main Accu-P® properties are:

- Enhanced RF power handling capability.
- Improved mechanical characteristics.
- Internationally agreed sizes with excellent dimensional control.
- Ultra Small size chip capacitors (0201) are available.
- Tight capacitance tolerances.
- Low ESR at UHF, VHF, and microwave frequencies.
- High-stability with respect to time, temperature, frequency and voltage variation.
- High temperature nickel/solder-coated terminations as standard to provide excellent solderability and leach resistance.

### ACCU-P® FEATURES

- Minimal batch to batch variability of parameters at high frequency.
- The Accu-P® has the same unique features as the Accu-F® capacitor such as low ESR, high Q, availability of very low capacitance values and very tight capacitance tolerances.
- The RF power handling capability of the Accu-P® allows for its usage in both small signal and RF power applications.
- Inspection, test and quality control procedures in accordance with ISO 9001, CECC, IECQ and USA MIL Standards guarantee product of the highest quality.
- Hand soldering Accu-P®: Due to their construction utilizing relatively high thermal conductivity materials, Accu-P's have become the preferred device in R & D labs and production environments where hand soldering is used. Accu-P's are available in all sizes and are electrically identical to their Accu-F counterparts.

### APPLICATIONS

- |  |                     |
|--|---------------------|
| Cellular Communications                              | Radar Systems       |
| CT2/PCN (Cordless Telephone/Personal Comm. Networks) | Video Switching     |
| Satellite TV   | Test & Measurements |
| Cable TV   | Filters             |
| GPS (Global Positioning Systems)                     | VCO's               |
| Vehicle Location Systems                             | Matching Networks   |
| Vehicle Alarm Systems                                | RF Amplifiers       |
| Paging   |                     |
| Military Communications                              |                     |

### APPROVALS

ISO 9001

# Accu-F® \*/ Accu-P®

## Thin-Film Chip Capacitors for RF Signal and Power Applications



### ACCU-F® \*(Signal Type Capacitors)

	0603	0805
<b>L</b>	1.60±0.1 (0.063±0.004)	2.01±0.1 (0.079±0.004)
<b>W</b>	0.81±0.1 (0.032±0.004)	1.27±0.1 (0.050±0.004)
<b>T</b>	0.63±0.1 (0.025±0.004)	0.63±0.1 (0.025±0.004)
<b>B</b>	0.30±0.1 (0.012±0.004)	0.30±0.1 (0.012±0.004)

\*Not recommended for new designs. Accu-P's are recommended. **DIMENSIONS:** millimeters (inches)

### ACCU-P® (Signal and Power Type Capacitors)

	0201	0402*	0603*	0805*	1210
<b>L</b>	0.60±0.05 (0.023±0.002)	1.00±0.1 (0.039±0.004)	1.60±0.1 (0.063±0.004)	2.01±0.1 (0.079±0.004)	3.02±0.1 (0.119±0.004)
<b>W</b>	0.325±0.050 (0.0128±0.002)	0.55±0.07 (0.022±0.003)	0.81±0.1 (0.032±0.004)	1.27±0.1 (0.050±0.004)	2.5±0.1 (0.100±0.004)
<b>T</b>	0.225±0.050 (0.009±0.002)	0.40±0.1 (0.016±0.004)	0.63±0.1 (0.025±0.004)	0.93±0.2 (0.036±0.008)	0.93±0.2 (0.036±0.008)
<b>B<sub>1</sub></b>	0.10±0.10 (0.004±0.004)	0.00 <sup>+0.1</sup> <sub>-0.0</sub> (0.000 <sup>+0.004</sup> <sub>-0.000</sub> )	0.35±0.15 (0.014±0.006)	0.30±0.1 (0.012±0.004)	0.43±0.1 (0.017±0.004)
<b>B<sub>2</sub></b>	0.15±0.05 (0.006±0.002)	0.20±0.1 (0.008±0.004)	0.35±0.15 (0.014±0.006)	0.30±0.1 (0.012±0.004)	0.43±0.1 (0.017±0.004)

\*Mount Black Side Up **DIMENSIONS:** millimeters (inches)

### HOW TO ORDER

<b>0402</b> T	<b>3</b> T	<b>J</b> T	<b>4R7</b> T	<b>A</b> T	<b>B</b> T	<b>S</b> T	<b>TR</b> T
<b>Size</b> 0201* 0402* 0603 0805 1210*	<b>Voltage</b> 1 = 100V 5 = 50V 3 = 25V Y = 16V Z = 10V	<b>Temperature Coefficient (1)</b> J = 0±30ppm/°C (-55°C to +125°C) K = 0±60ppm/°C (-55°C to +125°C)	<b>Capacitance</b> Capacitance expressed in pF. (2 significant digits + number of zeros) <b>for values &lt;10pF</b> , letter R denotes decimal point. Example: 68pF = 680, 8.2pF = 8R2	<b>Tolerance for C≤2.0pF*</b> P = ±0.02pF Q = ±0.03pF A = ±0.05pF B = ±0.1pF C = ±0.25pF <b>for C≤3.0pF</b> Q = ±0.03pF A = ±0.05pF B = ±0.1pF C = ±0.25pF <b>for C≤5.6pF</b> A = ±0.05pF B = ±0.1pF C = ±0.25pF <b>for 5.6pF&lt;C&lt;10pF</b> B = ±0.1pF C = ±0.25pF D = ±0.5pF <b>for C≥10pF</b> F = ±1% G = ±2% J = ±5%	<b>Specification Code</b> A = Accu-F® technology B = Accu-P® technology	<b>Termination Code</b> W = Nickel/Solder Coated <b>Accu-F®</b> Sn63, Pb37 <b>Accu-P® 0402</b> Sn90, Pb10 T = Nickel/High Temperature Solder Coated <b>Accu-P® 0805**, 1210**</b> Sn96, Ag4 Nickel/Solder Coated <b>Accu-P® 0603</b> Sn63, Pb37 **S = Nickel/Lead Free Solder Coated <b>Accu-P® 0201, 0402, 0603</b> Sn100  **RoHS Compliant	<b>Packaging Code</b> TR = Tape & Reel

\* Accu-P ONLY

(1) TC's shown are per EIA/IEC Specifications.



Please select correct termination style

**Engineering Kits Available**  
see pages 90-91

\*Tolerances as tight as ±0.01pF are available. Please consult the factory.

### ELECTRICAL SPECIFICATIONS

Operating and Storage Temperature Range	-55°C to +125°C
Temperature Coefficients (1)	0 ± 30ppm/°C dielectric code "J" / 0 ± 60ppm/°C dielectric code "K"
Capacitance Measurement	1 MHz, 1 Vrms
Insulation Resistance (IR)	≥10 <sup>11</sup> Ohms (≥10 <sup>10</sup> Ohms for 0201 and 0402 size)
Proof Voltage	2.5 U <sub>R</sub> for 5 secs.
Aging Characteristic	Zero
Dielectric Absorption	0.01%

(1) TC's shown are per EIA/IEC Specifications.



## Signal Type Capacitors

### Accu-F® Capacitance Ranges (pF)

#### TEMP. COEFFICIENT CODE

“J” = 0±30ppm/°C  
(-55°C to +125°C)<sup>(2)</sup>

Size		0603			0805		
Size Code		0603			0805		
Voltage		100	50	25	100	50	25
Cap in pF <sup>(1)</sup>	Cap code						
0.1	— 0R1						
0.2	— 0R2						
0.3	— 0R3						
0.4	— 0R4						
0.5	— 0R5						
0.6	— 0R6						
0.7	— 0R7						
0.8	— 0R8						
0.9	— 0R9						
1.0	— 1R0						
1.2	— 1R2						
1.5	— 1R5						
1.8	— 1R8						
2.2	— 2R2						
2.7	— 2R7						
3.3	— 3R3						
3.9	— 3R9						
4.7	— 4R7						
5.6	— 5R6						
6.8	— 6R8						
8.2	— 8R2						
10	— 100						
12	— 120						
15	— 150						
18	— 180						
22	— 220						
27	— 270						
33	— 330						
39	— 390						
47	— 470						
56	— 560						
68	— 680						
82	— 820						
100	— 101						
120	— 121						
150	— 151						

<sup>(1)</sup> For capacitance values higher than listed in table, please consult factory.

<sup>(2)</sup> TC shown is per EIA/IEC Specifications.

#### TEMP. COEFFICIENT CODE

“K” = 0±60ppm/°C  
(-55°C to +125°C)<sup>(2)</sup>

Size		0603			0805		
Size Code		0603			0805		
Voltage		100	50	25	100	50	25
Cap in pF <sup>(1)</sup>	Cap code						
0.1	— 0R1						
0.2	— 0R2						
0.3	— 0R3						
0.4	— 0R4						
0.5	— 0R5						
0.6	— 0R6						
0.7	— 0R7						
0.8	— 0R8						
0.9	— 0R9						
1.0	— 1R0						
1.2	— 1R2						
1.5	— 1R5						
1.8	— 1R8						
2.2	— 2R2						
2.7	— 2R7						
3.3	— 3R3						
3.9	— 3R9						
4.7	— 4R7						
5.6	— 5R6						
6.8	— 6R8						
8.2	— 8R2						
10	— 100						
12	— 120						
15	— 150						
18	— 180						
22	— 220						
27	— 270						
33	— 330						
39	— 390						
47	— 470						
56	— 560						
68	— 680						
82	— 820						
100	— 101						
120	— 121						
150	— 151						

<sup>(1)</sup> For capacitance values higher than listed in table, please consult factory.

<sup>(2)</sup> TC shown is per EIA/IEC Specifications.

Intermediate values are available within the indicated range.

\*Not recommended for new designs.  
Accu-P's are recommended.





## 0201 Typical Electrical Tables

Capacitance @ 1 MHz (pF)	Self Resonance Frequency (GHz) Typical	250MHz			500MHz			750MHz			1000MHz			1250MHz		
		Typ. C(eff) (pF)	Typ. Q	Typ. ESR (mΩ)	Typ. C(eff) (pF)	Typ. Q	Typ. ESR (mΩ)	Typ. C(eff) (pF)	Typ. Q	Typ. ESR (mΩ)	Typ. C(eff) (pF)	Typ. Q	Typ. ESR (mΩ)	Typ. C(eff) (pF)	Typ. Q	Typ. ESR (mΩ)
0.8	9.1	0.84	2154	360	0.84	630	603	0.85	424	594	0.85	327	577	0.86	255	588
1.2	7.6	1.21	1375	405	1.21	525	517	1.22	341	527	1.23	267	503	1.23	208	515
1.8	6.3	1.84	1298	271	1.85	520	341	1.86	337	347	1.87	270	326	1.88	201	347
2.2	5.7	2.23	1355	214	2.24	512	281	2.25	335	284	2.27	264	270	2.29	199	284
3.3	4.6	3.29	1295	156	3.31	430	230	3.33	285	230	3.36	220	223	3.40	159	242
3.9	4.3	3.91	1902	93	3.93	460	181	3.97	298	185	4.02	227	181	4.08	163	198
4.7	3.9	4.71	1677	84	4.74	391	174	4.80	252	178	4.87	181	183	4.97	130	200
5.6	3.6	5.62	1391	84	5.67	370	154	5.74	257	148	5.83	195	144	5.95	140	157
6.8	3.3	6.77	1135	84	6.83	314	149	6.91	217	142	7.03	164	139	7.18	118	151

Capacitance @ 1 MHz (pF)	Self Resonance Frequency (GHz) Typical	1500MHz			1750MHz			2250MHz			2500MHz			2750MHz		
		Typ. C(eff) (pF)	Typ. Q	Typ. ESR (mΩ)	Typ. C(eff) (pF)	Typ. Q	Typ. ESR (mΩ)	Typ. C(eff) (pF)	Typ. Q	Typ. ESR (mΩ)	Typ. C(eff) (pF)	Typ. Q M	Typ. ESR (mΩ)	Typ. C(eff) (pF)	Typ. Q	Typ. ESR (mΩ)
0.8	9.1	0.86	204	611	0.87	168	631	0.88	141	587	0.89	126	571	0.90	122	532
1.2	7.6	1.24	155	565	1.26	129	577	1.28	92	570	1.30	89	566	1.31	81	558
1.8	6.3	1.90	148	388	1.92	123	395	1.96	96	395	1.99	83	396	2.02	74	397
2.2	5.7	2.32	145	320	2.34	123	322	2.41	93	329	2.46	81	328	2.50	72	330
3.3	4.6	3.45	119	266	3.50	101	263	3.63	74	277	3.73	64	276	3.84	55	281
3.9	4.3	4.16	122	216	4.25	103	214	4.46	75	224	4.63	64	223	4.79	56	225
4.7	3.9	5.08	99	213	5.23	83	212	5.55	60	221	5.83	50	222	6.10	43	224
5.6	3.6	6.11	108	166	6.31	91	164	6.76	64	174	7.16	53	175	7.56	45	141
6.8	3.3	7.38	93	155	7.63	76	158	8.22	54	166	8.74	44	169	9.29	37	173







0402 Typical Electrical Tables



Capacitance & Tolerance* @ 1 MHz (pF)	Self Resonance Frequency (GHz) Typical	Ref Freq (MHz)	Typ. C(eff) (pF)	Typ. Q	Typ. ESR (Ω)	Ref Freq (MHz)	Typ. C(eff) (pF)	Typ. Q	Typ. ESR (Ω)	Ref Freq (MHz)	Typ. C(eff) (pF)	Typ. Q	Typ. ESR (Ω)	Ref Freq (MHz)	Typ. C(eff) (pF)	Typ. Q	Typ. ESR (Ω)	Ref Freq (MHz)	Typ. C(eff) (pF)	Typ. Q	Typ. ESR (Ω)	
0.1±0.05	19.4	n/a	n/a	n/a	n/a	n/a	n/a	n/a	n/a	n/a	n/a	n/a	n/a	n/a	n/a	n/a	n/a	n/a	n/a	n/a	n/a	n/a
0.2±0.05	16.4	n/a	n/a	n/a	n/a	n/a	n/a	n/a	n/a	n/a	n/a	n/a	n/a	n/a	n/a	n/a	n/a	n/a	n/a	n/a	n/a	n/a
0.3±0.05	14.6	n/a	n/a	n/a	n/a	n/a	n/a	n/a	n/a	n/a	n/a	n/a	n/a	n/a	n/a	n/a	n/a	n/a	n/a	n/a	n/a	n/a
0.4±0.05	12.5	n/a	n/a	n/a	n/a	n/a	n/a	n/a	n/a	n/a	n/a	n/a	n/a	n/a	n/a	n/a	n/a	n/a	n/a	n/a	n/a	n/a
0.5±0.05	11.3	n/a	n/a	n/a	n/a	n/a	n/a	n/a	n/a	n/a	n/a	n/a	n/a	n/a	n/a	n/a	n/a	n/a	n/a	n/a	n/a	n/a
0.6±0.05	10.4	n/a	n/a	n/a	n/a	n/a	n/a	n/a	n/a	n/a	n/a	n/a	n/a	n/a	n/a	n/a	n/a	n/a	n/a	n/a	n/a	n/a
0.7±0.05	9.5	n/a	n/a	n/a	n/a	n/a	n/a	n/a	n/a	n/a	n/a	n/a	n/a	n/a	n/a	n/a	n/a	n/a	n/a	n/a	n/a	n/a
0.8±0.05	9.1	n/a	n/a	n/a	n/a	n/a	n/a	n/a	n/a	n/a	n/a	n/a	n/a	n/a	n/a	n/a	n/a	n/a	n/a	n/a	n/a	n/a
0.9±0.05	8.8	n/a	n/a	n/a	n/a	n/a	n/a	n/a	n/a	n/a	n/a	n/a	n/a	n/a	n/a	n/a	n/a	n/a	n/a	n/a	n/a	n/a
1.00±0.05	8	1489	1.18	380	0.25	1739	1.25	314	0.25	1988	1.32	265	0.24	2240	1.38	229	0.23	2493	1.41	200	0.23	
1.10±0.05	7.8	1485	1.29	342	0.25	1735	1.33	275	0.25	1986	1.41	232	0.24	2238	1.49	201	0.24	2490	1.55	177	0.25	
1.20±0.05	7.4	1483	1.37	307	0.25	1732	1.45	251	0.25	1982	1.54	208	0.24	2234	1.59	173	0.25	2488	1.62	149	0.27	
1.30±0.05	7	1479	1.45	289	0.25	1729	1.58	240	0.25	1980	1.66	196	0.24	2230	1.73	166	0.25	2485	1.76	137	0.27	
1.40±0.05	6.8	1477	1.6	265	0.25	1726	1.71	221	0.25	1977	1.78	179	0.24	2229	1.88	154	0.25	2483	1.89	125	0.26	
1.50±0.05	6.5	1474	1.72	252	0.25	1724	1.82	203	0.25	1974	1.94	169	0.24	2227	2.01	143	0.25	2481	2.03	115	0.27	
1.60±0.05	6.5	1472	1.81	246	0.24	1722	1.91	201	0.24	1971	2.01	168	0.23	2226	2.1	142	0.24	2479	2.1	119	0.25	
1.70±0.05	6.4	1470	1.92	241	0.23	1719	1.99	199	0.23	1970	2.1	167	0.22	2225	2.23	141	0.23	2478	2.23	120	0.24	
1.80±0.05	6.2	1469	1.98	240	0.22	1718	2.06	198	0.22	1969	2.24	166	0.21	2223	2.34	141	0.22	2477	2.35	122	0.22	
1.90±0.05	6	1468	2.06	239	0.22	1717	2.19	197	0.21	1968	2.33	165	0.21	2222	2.41	140	0.21	2476	2.42	123	0.21	
2.00±0.05	5.7	1466	2.12	233	0.21	1716	2.22	190	0.21	1968	2.51	160	0.20	2220	2.62	138	0.21	2475	2.65	118	0.21	
2.10±0.05	5.4	1463	2.31	230	0.20	1714	2.43	185	0.21	1966	2.62	155	0.20	2219	2.76	132	0.2	2474	2.81	115	0.20	
2.20±0.05	5.1	1461	2.47	228	0.20	1711	2.65	183	0.20	1964	2.83	149	0.20	2217	2.91	126	0.19	2473	2.91	108	0.20	
2.30±0.05	5	1460	2.51	214	0.20	1709	2.81	168	0.20	1963	2.98	132	0.19	2216	3.15	121	0.19	2471	3.16	99	0.22	
2.40±0.05	4.9	1459	2.6	196	0.20	1708	3	151	0.20	1962	3.16	120	0.19	2215	3.42	109	0.2	2469	3.42	91	0.23	
2.50±0.05	4.7	1458	2.77	182	0.20	1706	3.12	144	0.20	1960	3.32	112	0.19	2214	3.58	92	0.21	2468	3.66	81	0.23	
2.60±0.05	4.6	1455	2.85	173	0.20	1705	3.25	132	0.20	1957	3.51	97	0.19	2212	3.73	85	0.22	2467	3.73	72	0.24	
2.70±0.05	4.5	1453	3.18	164	0.20	1703	3.47	122	0.20	1956	3.75	94	0.20	2211	3.89	78	0.24	2466	3.89	66	0.25	
2.80±0.05	4.5	1451	3.25	159	0.20	1702	3.62	120	0.20	1956	3.93	88	0.20	2210	3.97	75	0.24	2466	4.03	65	0.25	
2.90±0.05	4.4	1450	3.33	156	0.19	1702	3.77	117	0.20	1956	4.02	84	0.20	2210	4.12	73	0.24	2466	4.17	63	0.25	
3.00±0.05	4.4	1449	3.49	150	0.19	1701	3.99	114	0.20	1955	4.21	81	0.20	2209	4.26	72	0.24	2465	4.21	61	0.25	
3.10±0.05	4.4	1448	3.61	148	0.19	1700	4.16	109	0.20	1952	4.4	79	0.20	2209	4.45	70	0.24	2465	4.33	59	0.25	
3.20±0.05	4.3	1447	3.7	145	0.19	1700	4.31	105	0.20	1952	4.62	77	0.19	2208	4.62	69	0.23	2464	4.49	58	0.25	
3.30±0.05	4.3	1446	3.79	143	0.19	1699	4.47	101	0.20	1951	4.76	76	0.20	2207	4.81	68	0.23	2464	4.66	55	0.25	
3.40±0.05	4.3	1446	4.01	138	0.19	1698	4.62	101	0.20	1950	4.92	75	0.20	2206	4.93	66	0.22	2464	4.92	52	0.24	
3.50±0.05	4.2	1445	4.11	133	0.19	1697	4.78	95	0.20	1950	5.18	73	0.19	2206	5.21	65	0.23	2463	5.15	51	0.24	
3.60±0.05	4.2	1445	4.2	130	0.19	1697	4.91	94	0.20	1949	5.34	71	0.20	2205	5.4	63	0.22	2463	5.25	51	0.24	
3.70±0.05	4.1	1444	4.28	126	0.19	1696	5.05	92	0.19	1949	5.5	69	0.20	2205	5.62	62	0.22	2462	5.41	49	0.24	
3.80±0.05	4	1443	4.44	125	0.19	1696	5.11	90	0.19	1948	5.61	67	0.20	2204	5.78	61	0.22	2462	5.66	48	0.24	
3.90±0.05	3.9	1442	4.72	121	0.19	1695	5.26	89	0.19	1948	5.77	66	0.21	2204	5.94	60	0.22	2461	5.82	47	0.24	
4.00±0.05	3.9	1441	4.8	121	0.18	1694	5.38	88	0.19	1947	5.81	66	0.20	2203	6.03	60	0.21	2461	5.86	48	0.23	
4.10±0.05	3.8	1440	4.92	121	0.18	1693	5.5	87	0.19	1947	5.93	65	0.19	2203	6.11	60	0.21	2460	5.9	49	0.23	
4.20±0.05	3.8	1440	5.01	120	0.18	1692	5.63	87	0.18	1946	6.05	65	0.18	2203	6.24	59	0.21	2460	5.95	49	0.21	
4.30±0.05	3.7	1439	5.17	120	0.18	1692	5.78	85	0.18	1946	6.11	64	0.18	2202	6.35	58	0.2	2459	6.01	50	0.20	
4.40±0.05	3.7	1439	5.28	119	0.18	1691	5.91	85	0.18	1945	6.23	64	0.18	2202	6.4	57	0.2	2459	6.12	52	0.20	
4.50±0.05	3.6	1438	5.41	119	0.18	1691	6.04	81	0.18	1945	6.45	64	0.19	2201	6.52	56	0.19	2458	6.23	52	0.19	
4.60±0.05	3.6	1438	5.49	118	0.17	1691	6.11	80	0.18	1944	6.66	63	0.17	2201	6.67	55	0.18	2458	6.29	54	0.19	
4.70±0.05	3.5	1437	5.6	118	0.17	1690	6.23	80	0.18	1944	6.72	63	0.17	2200	6.71	56	0.18	2457	6.35	54	0.19	
5.10±0.05	3.4	1435	6.59	105	0.17	1689	7.48	75	0.18	1943	7.97	60	0.19	2200	8.11	45	0.2	2456	8.1	39	0.21	
5.60±0.05	3.3	1434	7.43	90	0.17	1687	8.75	61	0.17	1942	10.03	51	0.21	2199	10.42	37	0.22	2456	10.07	28	0.23	
6.2±0.1	3	1432	8.27	91	0.15	1686	10.21	60	0.15	1941	11.52	48	0.18	2198	11.88	36	0.18	2455	11.02	33	0.19	
6.8±0.1	2.8	1430	9.41	88	0.13	1684	11.43	58	0.13	1940	13.36	45	0.14	2196	13.72	37	0.14	2454	12.85	36	0.14	
7.5±0.1	2.7	1429	10.05	85	0.13	1683	12.25	56	0.14	1939	15.06	40	0.13	2195	15.24	35	0.15	2454	13.66	33	0.14	
8.2±0.1	2.6	1428	11.64	79	0.13	1682	14.43	52	0.13	1938	16.85	38	0.13	2195	16.65	32	0.14	2453	15.32	31	0.14	
9.1±0.1	2.5	1427	13.39	60	0.13	1681	19.07	33	0.14	1937	28.35	25	0.15	2194	31.08	15	0.16	2452	29.91	15	0.16	
10.0±1%	2.4	1425	17.6	41	0.14	1680	26.51	21	0.16	1936	40.16	11	0.17	2194	45.46	8	0.18	2452	39.54	8	0.18	
11.0±1%	2.3	1424	20.09	36	0.15	1679	32.66	19	0.15	1935	66.25	8	0.17	2192	81.07	5	0.2	2451	61.28	6	0.18	
12.0±1%	2.2	1423	24.14	29	0.15	1678	43.51	13	0.14	1934	92.97	5	0.18	2192	123.19	3	0.2	2450	82.44	4	0.19	
13.0±1%	2.2	1417	48.3	18	0.13	1671	63.2	5	0.17	1934	125	3	0.18	2191			0.2					
14.0±1%	2.1	1422	39.55	17	0.15	1677	122	2	0.21	1934	180.3	1	0.19	2191			0.18					
15.0±1%	2.1	1421	38.93	20	0.14	1676	154	2	0.17	1933	244.5		0.16	2191			0.161					
16.0±1%	2	1416	79.3	12	0.14	1670			0.17	1932			0.16	2191			0.16					
17.0±1%	1.9	1415	77.6	11	0.14	1670			0.17	1932			0.16	2191			0.16					
18.0±1%	1.8	1411	83.13	9	0.15	1675			0.17	1932			0.16	2182								

# Accu-F® / Accu-P®

## 0603 Typical Electrical Tables



1

Capacitance & Tolerance* @ 1 MHz (pF)	Self Resonance Frequency (GHz)	Ref Freq. MHz	Effective Capacitance Max/Min (pF)	Max ESR (Ω)	Ref Freq. MHz	Effective Capacitance Max/Min (pF)	Max ESR (Ω)	Ref Freq. MHz	Effective Capacitance Max/Min (pF)	Max ESR (Ω)	Ref Freq. MHz	Effective Capacitance Max/Min (pF)	Max ESR (Ω)
0.1±0.05	18.0		N/A	N/A	N/A	N/A	N/A	N/A	N/A	N/A	N/A	N/A	N/A
0.2±0.05	12.7		N/A	N/A	N/A	N/A	N/A	N/A	N/A	N/A	N/A	N/A	N/A
0.3±0.05	10.4		N/A	N/A	N/A	N/A	N/A	N/A	N/A	N/A	N/A	N/A	N/A
0.4±0.05	9.0		N/A	N/A	N/A	N/A	N/A	N/A	N/A	N/A	N/A	N/A	N/A
0.5±0.05	8.1		N/A	N/A	N/A	N/A	N/A	N/A	N/A	N/A	N/A	N/A	N/A
0.6±0.10	7.4		N/A	N/A	N/A	N/A	N/A	N/A	N/A	N/A	N/A	N/A	N/A
0.7±0.10	6.8		N/A	N/A	N/A	N/A	N/A	N/A	N/A	N/A	N/A	N/A	N/A
0.8±0.10	6.4		N/A	N/A	N/A	N/A	N/A	N/A	N/A	N/A	N/A	N/A	N/A
0.9±0.10	6.0		N/A	N/A	N/A	N/A	N/A	N/A	N/A	N/A	N/A	N/A	N/A
1.0±0.10	5.7	245	1.15/0.90	.280	491	1.10/0.90	.220	738	1.10/0.90	.220	987	1.15/0.90	.300
1.1±0.10	5.4	244	1.25/1.00	.270	490	1.25/1.00	.210	736	1.11/1.00	.210	985	1.25/1.00	.290
1.2±0.10	5.2	243	1.35/1.10	.260	487	1.35/1.05	.200	734	1.40/1.05	.210	981	1.35/1.05	.280
1.3±0.10	5.0	242	1.45/1.15	.260	486	1.45/1.15	.200	732	1.45/1.15	.200	974	1.45/1.15	.270
1.4±0.10	4.8	241	1.55/1.25	.250	485	1.55/1.25	.190	731	1.45/1.25	.200	977	1.55/1.25	.260
1.5±0.10	4.7	241	1.65/1.35	.250	484	1.65/1.35	.180	729	1.65/1.35	.190	976	1.70/1.35	.250
1.6±0.10	4.5	240	1.75/1.45	.240	483	1.75/1.45	.180	727	1.75/1.45	.190	973	1.80/1.50	.250
1.7±0.10	4.4	240	1.85/1.55	.230	482	1.85/1.60	.170	725	1.85/1.60	.180	971	1.90/1.60	.250
1.8±0.10	4.2	239	2.10/1.70	.220	479	2.10/1.70	.160	723	2.10/1.70	.170	969	2.15/1.70	.250
1.9±0.10	4.1	239	2.15/1.78	.210	478	2.15/1.80	.160	721	2.15/1.80	.167	967	2.20/1.80	.240
2.0±0.10	4.0	238	2.11/1.80	.205	477	2.11/1.80	.155	720	2.11/1.80	.165	966	2.25/1.90	.230
2.1±0.10	3.9	237	2.25/1.95	.200	475	2.25/1.98	.150	718	2.35/1.98	.162	964	2.35/2.00	.220
2.2±0.10	3.8	236	2.40/2.05	.190	474	2.45/2.05	.145	717	2.42/2.05	.160	962	2.45/2.10	.210
2.4±0.25	3.7	234	2.70/2.15	.175	471	2.75/2.15	.140	713	2.80/2.15	.150	958	2.80/2.15	.200
2.7±0.25	3.5	232	3.00/2.45	.160	468	3.10/2.45	.125	709	3.10/2.45	.145	954	3.15/2.48	.190
3.0±0.25	3.3	230	3.40/2.75	.150	465	3.40/2.75	.120	706	3.40/2.75	.140	951	3.60/2.80	.170
3.3±0.25	3.1	226	3.60/3.05	.130	459	3.70/3.05	.120	699	3.70/3.05	.130	945	3.80/3.10	.165
3.6±0.25	3.0	224	3.90/3.30	.128	456	4.25/3.35	.119	697	3.90/3.35	.125	942	4.10/3.40	.160
3.9±0.25	2.9	223	4.20/3.65	.125	455	4.35/3.70	.115	695	4.90/3.75	.120	940	5.15/3.75	.150
4.3±0.25	2.7	220	4.60/4.00	.122	451	4.80/4.05	.117	692	5.10/4.05	.115	937	5.30/4.05	.150
4.7±0.25	2.6	218	5.00/4.45	.120	448	5.20/4.45	.110	689	5.30/4.50	.115	935	5.50/4.55	.145
5.1±0.25	2.5	216	5.40/4.85	.115	445	5.70/4.89	.105	686	6.00/4.90	.115	931	6.20/5.00	.140
5.6±0.25	2.4	214	5.90/5.35	.110	443	6.10/5.35	.100	684	6.15/5.40	.110	929	6.50/5.50	.135
6.2±0.25	2.3	211	6.50/5.95	.105	439	6.90/5.95	.099	680	7.10/6.00	.110	927	8.00/6.10	.130
6.8±0.25	2.2	208	7.20/6.55	.100	435	7.25/6.55	.099	677	7.50/6.60	.110	925	9.00/6.65	.130
7.5±0.50	2.1	205	8.10/7.00	.095	432	8.10/7.00	.099	675	8.20/7.00	.110	925	9.50/7.05	.125
8.2±0.50	2.0	202	8.80/7.70	.090	429	8.80/7.70	.098	672	9.00/7.70	.110	921	10.00/7.80	.125
9.1±0.50	1.9	200	9.80/8.60	.090	425	10.95/8.65	.098	670	12.00/9.00	.110	919	13.00/9.10	.120
10±5%	1.8	195	10.70/9.50	.085	422	11.60/9.50	.097	667	12.50/9.60	.110	917	16.00/9.90	.120
11±5%	1.7	191	11.60/10.90	.085	420	12.20/10.60	.095	665	13.20/10.50	.110	916	17.00/10.00	.120
12±5%	1.6	189	12.90/11.40	.085	418	13.40/11.50	.095	663	14.60/11.90	.110	914	18.00/12.00	.120
13±5%	1.6	187	13.10/12.90	.080	416	14.00/13.00	.095	661	16.00/13.50	.110	913	21.00/14.00	.120
14±5%	1.5	185	14.90/13.25	.080	414	16.90/14.00	.090	660	19.00/15.00	.110	912	26.00/15.00	.120
15±5%	1.5	182	15.90/14.25	.080	412	17.50/15.30	.090	659	21.00/16.50	.100	911	29.00/17.00	.120
16±5%	1.4	179	17.00/15.15	.070	410	18.00/15.90	.085	657	22.00/17.00	.100	910	30.00/18.00	.120
18±5%	1.3	176	19.50/17.00	.070	408	20.20/17.10	.085	656	23.70/19.00	.100	908	33.00/21.00	.120
22±5%	1.2	170	24.00/20.90	.066	404	25.00/20.90	.080	654	28.00/21.00	.10	906	39.00/21.50	.120
24±5%	1.2	168	26.00/22.80	.066	403	30.00/23.00	.080	653	N/A	.10	905	N/A	.120
27±5%	1.1	165	29.00/25.60	.065	402	36.00/27.00	.080	652	N/A	.10	905	N/A	.120
30±5%	1.0	163	32.00/28.50	.064	401	40.00/30.00	.080	651	N/A	.10	904	N/A	.120
33±5%	1.0	160	37.65/31.35	.064	400	45.00/33.00	.080	650	N/A	.10	904	N/A	.120

\* Other tolerances are available, see page 8



# Accu-F® / Accu-P®

## 0805 Typical Electrical Tables



1

Capacitance & Tolerance* @ 1 MHz (pF)	Self Resonance Frequency (GHz)	Ref Freq. MHz	Effective Capacitance Max/Min (pF)	Max ESR (Ω)	Ref Freq. MHz	Effective Capacitance Max/Min (pF)	Max ESR (Ω)	Ref Freq. MHz	Effective Capacitance Max/Min (pF)	Max ESR (Ω)	Ref Freq. MHz	Effective Capacitance Max/Min (pF)	Max ESR (Ω)
0.1±0.05			N/A	N/A	N/A	N/A	N/A	N/A	N/A	N/A	N/A	N/A	N/A
0.2±0.05			N/A	N/A	N/A	N/A	N/A	N/A	N/A	N/A	N/A	N/A	N/A
0.3±0.05			N/A	N/A	N/A	N/A	N/A	N/A	N/A	N/A	N/A	N/A	N/A
0.4±0.05			N/A	N/A	N/A	N/A	N/A	N/A	N/A	N/A	N/A	N/A	N/A
0.5±0.05			N/A	N/A	N/A	N/A	N/A	N/A	N/A	N/A	N/A	N/A	N/A
0.6±0.10			N/A	N/A	N/A	N/A	N/A	N/A	N/A	N/A	N/A	N/A	N/A
0.7±0.10			N/A	N/A	N/A	N/A	N/A	N/A	N/A	N/A	N/A	N/A	N/A
0.8±0.10			N/A	N/A	N/A	N/A	N/A	N/A	N/A	N/A	N/A	N/A	N/A
0.9±0.10			N/A	N/A	N/A	N/A	N/A	N/A	N/A	N/A	N/A	N/A	N/A
1.0±0.10	5.6	250	1.20/0.90	.320	500	1.20/0.90	.300	750	1.20/0.90	.270	999	1.20/0.90	.300
1.1±0.10	5.4	248	1.30/1.00	.290	496	1.30/1.00	.270	754	1.30/1.00	.250	993	1.30/1.00	.290
1.2±0.10	5.1	245	1.40/1.10	.270	492	1.40/1.10	.250	739	1.40/1.10	.240	987	1.40/1.10	.280
1.3±0.10	4.9	243	1.50/1.20	.260	488	1.50/1.20	.230	734	1.50/1.10	.230	980	1.50/1.10	.270
1.4±0.10	4.8	242	1.60/1.30	.240	487	1.60/1.20	.220	733	1.60/1.20	.220	979	1.60/1.30	.260
1.5±0.10	4.6	242	1.70/1.40	.230	486	1.70/1.40	.210	731	1.70/1.40	.220	977	1.70/1.40	.260
1.6±0.10	4.5	241	1.80/1.50	.220	484	1.85/1.50	.210	729	2.00/1.50	.220	975	2.00/1.50	.250
1.7±0.10	4.3	240	1.90/1.60	.210	483	1.95/1.60	.200	728	2.05/1.60	.210	974	2.20/1.60	.240
1.8±0.10	4.2	239	2.00/1.70	.200	482	2.05/1.70	.190	726	2.10/1.70	.210	972	2.30/1.70	.230
1.9±0.10	4.1	239	2.10/1.80	.200	481	2.15/1.80	.190	724	2.25/1.80	.200	970	2.40/1.80	.230
2.0±0.10	4.0	238	2.20/1.90	.190	479	2.30/1.90	.180	722	2.40/1.90	.200	967	2.60/1.95	.220
2.1±0.10	3.9	237	2.30/2.00	.190	477	2.40/2.00	.170	720	2.60/2.00	.190	964	2.80/2.06	.210
2.2±0.10	3.8	236	2.40/2.10	.180	475	2.60/2.10	.170	716	2.80/2.14	.190	962	3.06/2.17	.210
2.4±0.25	3.6	235	2.85/2.15	.170	473	3.13/2.29	.170	714	3.17/2.30	.190	960	3.31/2.31	.210
2.7±0.25	3.4	233	3.19/2.45	.160	470	3.47/2.55	.150	711	3.52/2.60	.170	957	3.67/2.60	.200
3.0±0.25	3.3	231	3.51/2.75	.150	465	3.76/2.86	.140	707	3.84/2.93	.160	952	4.00/3.00	.190
3.3±0.25	3.1	229	3.83/3.05	.140	463	4.04/3.10	.140	704	4.15/3.19	.160	948	4.38/3.30	.190
3.6±0.25	3.0	228	4.16/3.35	.140	462	4.35/3.42	.130	704	4.50/3.53	.150	947	4.80/3.60	.190
3.9±0.25	2.9	227	4.48/3.65	.130	459	4.67/3.72	.120	701	4.85/3.86	.150	944	5.23/3.90	.180
4.3±0.25	2.7	223	4.91/4.05	.130	456	5.11/4.13	.120	697	5.32/4.25	.150	940	5.79/4.50	.180
4.7±0.25	2.6	220	5.35/4.45	.120	451	5.52/4.53	.110	691	5.79/4.60	.140	936	6.36/4.80	.170
5.1±0.25	2.5	218	5.78/4.85	.120	447	5.94/4.94	.110	688	6.25/5.20	.140	934	7.16/5.74	.160
5.6±0.25	2.4	215	6.00/5.35	.100	444	6.82/5.40	.100	684	7.27/5.60	.120	930	8.25/5.90	.150
6.2±0.25	2.3	212	7.00/5.95	.100	442	7.52/6.00	.100	683	8.08/6.10	.120	927	9.35/6.80	.150
6.8±0.25	2.2	208	7.20/6.55	.100	435	8.21/6.88	.100	677	8.90/6.96	.120	925	10.46/7.32	.150
7.5±0.05	2.1	206	8.64/7.00	.100	434	9.02/7.10	.100	675	9.85/7.50	.120	924	11.75/8.42	.150
8.2±0.05	2.0	203	9.40/7.70	.090	432	9.83/7.90	.080	673	10.80/8.25	.110	922	13.04/9.53	.150
9.1±0.05	1.9	199	10.37/8.60	.080	429	10.88/8.76	.080	670	12.02/9.10	.110	920	14.70/10.70	.150
10±5%	1.8	196	11.00/9.50	.080	423	11.92/9.76	.080	668	13.24/10.00	.110	918	15.37/11.80	.140
11±5%	1.8	193	12.50/10.45	.080	420	13.23/10.50	.080	665	15.07/11.00	.110	916	16.00/12.20	.140
12±5%	1.6	190	13.61/11.40	.070	418	14.50/11.90	.080	663	16.90/12.82	.110	915	N/A	.140
13±5%	1.6	187	14.75/12.35	.070	416	15.80/13.00	.080	662	18.87/14.00	.110	914	N/A	.140
14±5%	1.5	184	15.88/13.30	.070	414	17.22/14.00	.080	661	20.84/16.00	.110	913	N/A	.140
15±5%	1.5	182	17.02/14.25	.070	414	18.56/15.19	.080	660	22.62/19.13	.110	912	N/A	.130
16±5%	1.4	179	18.16/15.20	.070	411	19.90/16.28	.080	659	27.00/20.89	.100	911	N/A	.130
18±5%	1.3	176	20.42/17.10	.070	408	22.69/18.57	.070	657	33.00/22.10	.100	910	N/A	.130
20±5%	1.3	173	22.70/19.00	.060	406	25.38/20.78	.070	656	38.00/23.15	.100	908	N/A	.130
22±5%	1.2	171	24.95/20.90	.060	405	28.08/21.00	.070	655	42.00/24.00	.100	907	N/A	.130
24±5%	1.2	168	27.20/22.80	.060	403	31.31/25.61	.070	654	N/A	.090	907	N/A	.130
27±5%	1.1	165	30.78/25.69	.060	401	36.10/32.20	.070	652	N/A	.090	906	N/A	.130
30±5%	1.0	163	34.23/28.50	.050	400	40.58/33.20	.070	651	N/A	.090	905	N/A	.130
33±5%	1.0	159	37.85/31.35	.050	399	46.65/35.00	.070	650	N/A	.090	904	N/A	.120
36±5%	0.9	157	41.19/34.20	.050	397	52.22/38.00	.070	649	N/A	.090	903	N/A	.120
39±5%	0.9	155	44.79/37.05	.050	396	59.08/47.08	.070	648	N/A	.090	902	N/A	.120
43±5%	0.9	153	49.99/40.85	.050	395	70.50/53.04	.060	647	N/A	.090	901	N/A	.120
47±5%	0.8	152	55.19/44.65	.050	394	81.99/59.00	.060	646	N/A	.090	900	N/A	.110

\* Other tolerances are available, see page 8

## 1210 Typical Electrical Tables

1

Capacitance & Tolerance* @ 1 MHz (pF)	Self Resonance Frequency (GHz)	Ref Freq. (MHz)	Effective Capacitance Max/Min (pF)	Max ESR (Ω)	Ref Freq. (MHz)	Effective Capacitance Max/Min (pF)	Max ESR (Ω)	Ref Freq. (MHz)	Effective Capacitance Max/Min (pF)	Max ESR (Ω)	Ref Freq. (MHz)	Effective Capacitance Max/Min (pF)	Max ESR (Ω)
1.0±0.25	4.98	247	1.23/0.75	.350	495	1.34/0.86	.260	745	1.46/0.94	.280	995	1.6/0.99	.350
1.2±0.25	4.55	245	1.32/0.95	.310	491	1.45/1.00	.240	739	1.64/1.1	.260	987	2.00/1.2	.320
1.5±0.25	4.07	242	1.6/1.23	.250	486	1.75/1.3	.230	731	1.82/1.95	.250	978	2.1/1.4	.270
1.8±0.25	9.71	240	2.1/1.55	.200	482	2.21/1.56	.200	731	2.4/1.6	.200	978	2.54/1.7	.210
2.2±0.25	9.96	237	2.48/1.95	.170	476	2.68/2.00	.170	727	2.85/2.1	.180	969	3.02/2.2	.200
2.7±0.25	2.70	233	3.42/2.45	.140	466	3.49/2.55	.140	708	3.73/2.63	.150	952	3.89/2.70	.170
3.3±0.25	2.60	229	4.02/3.05	.140	463	4.09/3.15	.130	704	4.33/3.23	.140	948	4.49/3.30	.160
3.6±0.25	2.50	228	4.18/3.35	.130	462	4.32/3.43	.130	704	4.50/3.32	.140	947	4.78/3.45	.160
3.9±0.25	2.40	227	4.53/3.65	.130	458	4.66/3.73	.120	701	4.85/3.75	.140	944	5.18/3.90	.150
4.3±0.25	2.30	223	5.01/4.05	.120	456	5.11/4.14	.110	697	5.32/4.29	.130	940	5.72/4.30	.140
4.7±0.25	2.20	220	5.48/4.45	.120	451	5.62/4.50	.110	691	5.94/4.60	.130	936	6.56/4.70	.140
5.1±0.25	2.10	218	5.88/4.85	.110	447	6.04/4.90	.110	683	6.36/5.10	.130	933	7.20/5.40	.140
5.6±0.25	2.00	215	6.49/5.35	.110	441	6.72/5.56	.100	681	7.17/5.67	.120	928	8.15/6.00	.140
6.2±0.25	1.90	212	7.19/5.95	.100	442	7.26/6.07	.100	679	7.99/6.10	.110	927	9.18/7.00	.130
6.8±0.25	1.80	208	7.38/6.55	.100	435	8.16/6.42	.100	677	8.81/6.93	.110	925	10.20/7.42	.130
7.5±0.25	1.70	206	8.60/7.90	.100	434	8.90/7.25	.100	675	9.58/7.60	.100	924	11.36/8.00	.130
8.2±0.25	1.70	203	9.36/7.70	.100	432	9.76/7.96	.090	673	10.68/8.31	.100	922	13.00/9.10	.130
9.1±0.25	1.60	199	10.34/8.60	.090	429	10.87/8.88	.090	670	12.10/9.66	.090	920	15.11/10.25	.130
10±5%	1.50	196	11.33/9.50	.090	423	11.97/9.79	.090	668	13.51/10.05	.090	918	17.22/11.06	.130
11±5%	1.50	193	12.50/10.45	.090	420	13.23/10.83	.090	665	15.07/11.33	.090	916	N/A	.130
12±5%	1.40	190	13.61/11.40	.080	418	14.59/11.90	.080	663	16.90/12.82	.090	915	N/A	.120
13±5%	1.30	185	14.75/12.35	.080	416	15.64/13.00	.080	662	18.80/13.60	.090	914	N/A	.120
14±5%	1.30	183	15.89/13.30	.080	415	17.22/14.00	.080	661	20.85/16.00	.090	913	N/A	.120
15±5%	1.20	182	17.02/14.25	.080	414	18.56/15.19	.080	660	22.62/17.00	.090	912	N/A	.110
16±5%	1.20	180	18.16/15.20	.080	411	19.90/16.28	.080	659	25.12/18.00	.090	911	N/A	.110
18±5%	1.10	176	20.42/17.10	.070	408	22.69/18.57	.080	657	30.00/24.00	.080	909	N/A	.110
20±5%	1.10	173	22.70/19.00	.070	406	25.36/20.78	.080	656	35.00/26.00	.080	908	N/A	.110
22±5%	1.00	171	24.95/20.90	.070	405	28.06/22.96	.080	655	42.00/27.00	.080	908	N/A	.110
24±5%	0.98	168	27.20/22.60	.070	403	31.31/25.60	.080	654	N/A	.080	907	N/A	.110
25±5%	0.96	166	26.39/23.75	.070	402	32.91/26.00	.080	653	N/A	.080	907	N/A	.110
27±5%	0.92	164	30.78/25.65	.070	401	36.10/28.00	.070	652	N/A	.080	906	N/A	.110
28±5%	0.91	163	31.93/26.50	.070	401	37.60/30.76	.070	651	N/A	.080	906	N/A	.110
30±5%	0.88	162	34.23/28.50	.070	400	40.50/33.20	.070	651	N/A	.080	905	N/A	.110
32±5%	0.85	161	36.51/30.40	.070	399	44.63/34.50	.070	650	N/A	.080	905	N/A	.110
33±5%	0.84	159	37.65/31.35	.060	399	46.65/35.00	.070	650	N/A	.080	905	N/A	.110
34±5%	0.82	158	38.83/32.30	.060	398	48.51/37.00	.070	649	N/A	.080	904	N/A	.110
36±5%	0.80	157	41.20/34.20	.060	397	52.22/41.00	.070	649	N/A	.070	904	N/A	.110
39±5%	0.77	155	44.79/37.05	.060	396	59.00/43.00	.070	649	N/A	.070	904	N/A	.110
43±5%	0.73	153	49.99/40.85	.060	396	70.00/46.00	.070	648	N/A	.070	904	N/A	.110
47±5%	0.70	152	55.69/44.65	.060	395	81.00/53.00	.070	648	N/A	.070	903	N/A	.110

\* Other tolerances are available, see page 8

Typical ESR vs. Frequency  
Accu-P® 0201



Typical SRF vs. Capacitance  
Accu-P® 0201



Typical Q vs. Frequency  
Accu-P® 0201



# Accu-F® / Accu-P®

## High Frequency Characteristics



1

Typical ESR vs. Frequency  
Accu-P® 0402



Typical ESR vs. Frequency  
Accu-F®/Accu-P® 0603



Typical Q vs. Frequency  
Accu-P® 0402



Typical Q vs. Frequency  
Accu-F®/Accu-P® 0603



Typical Self Resonant Frequency vs. Capacitance  
Accu-P® 0402



Typical Self Resonant Frequency vs. Capacitance  
Accu-F®/Accu-P® 0603



# Accu-F® / Accu-P®

## High Frequency Characteristics



1

Typical ESR vs. Frequency  
Accu-F®/Accu-P® 0805



Typical ESR vs. Frequency  
Accu-P® 1210



Typical Q vs. Frequency  
Accu-F®/Accu-P® 0805



Typical Q vs. Frequency  
Accu-P® 1210



Typical Self Resonant Frequency vs. Capacitance  
Accu-F®/Accu-P® 0805

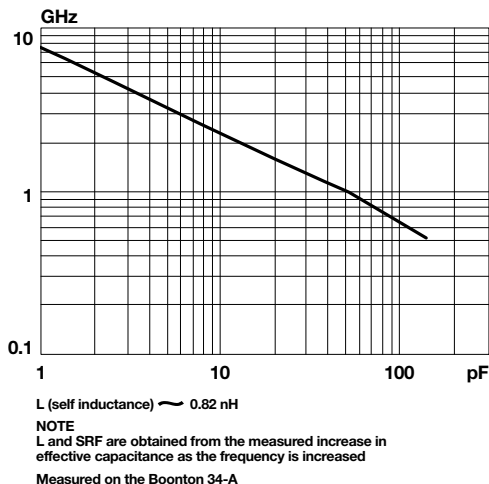

Typical Self Resonant Frequency vs. Capacitance  
Accu-P® 1210

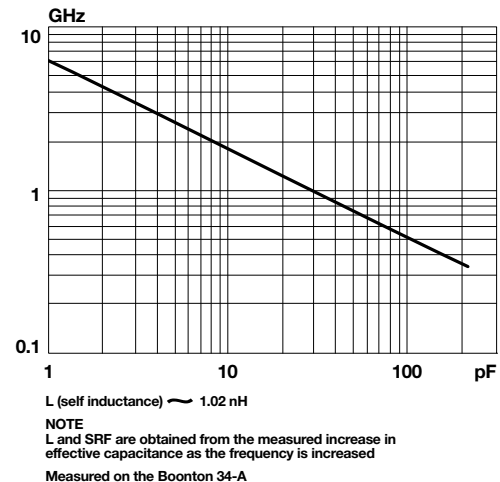

### ENVIRONMENTAL CHARACTERISTICS

TEST	CONDITIONS	REQUIREMENT
<b>Life (Endurance)</b> MIL-STD-202F Method 108A	125°C, 2U <sub>R</sub> , 1000 hours	No visible damage ∅C/C ≤ 2% for C≥5pF ∅C ≤ 0.25pF for C<5pF
<b>Accelerated Damp Heat Steady State</b> MIL-STD-202F Method 103B	85°C, 85% RH, U <sub>R</sub> , 1000 hours	No visible damage ∅C/C ≤ 2% for C≥5pF ∅C ≤ 0.25pF for C<5pF
<b>Temperature Cycling</b> MIL-STD-202F Method 107E MIL-STD-883D Method 1010.7	-55°C to +125°C, 15 cycles – Accu-P® -55°C to +125°C, 5 cycles – Accu-F®	No visible damage ∅C/C ≤ 2% for C≥5pF ∅C ≤ 0.25pF for C<5pF
<b>Resistance to Solder Heat</b> IEC-68-2-58	260°C ± 5°C for 10 secs	C remains within initial limits

### MECHANICAL CHARACTERISTICS

TEST	CONDITIONS	REQUIREMENT
<b>Solderability</b> IEC-68-2-58	Components completely immersed in a solder bath at 235°C for 2 secs.	Terminations to be well tinned, minimum 95% coverage
<b>Leach Resistance</b> IEC-68-2-58	Components completely immersed in a solder bath at 260±5°C for 60 secs.	Dissolution of termination faces ≤15% of area Dissolution of termination edges ≤25% of length
<b>Adhesion</b> MIL-STD-202F Method 211A	A force of 5N applied for 10 secs.	No visible damage
<b>Termination Bond Strength</b> IEC-68-2-21 Amend. 2	Tested as shown in diagram  D = 3mm Accu-P D = 1mm Accu-F	No visible damage ∅C/C ≤ 2% for C≥5pF ∅C ≤ 0.25pF for C<5pF
<b>Robustness of Termination</b> IEC-68-2-21 Amend. 2	A force of 5N applied for 10 secs.	No visible damage
<b>High Frequency Vibration</b> MIL-STD-202F Method 201A, 204D (Accu-P® only)	55Hz to 2000Hz, 20G	No visible damage
<b>Storage</b>	12 months minimum with components stored in “as received” packaging	Good solderability

### QUALITY & RELIABILITY

Accu-P® is based on well established thin-film technology and materials.

#### • ON-LINE PROCESS CONTROL

This program forms an integral part of the production cycle and acts as a feedback system to regulate and control production processes. The test procedures, which are integrated into the production process, were developed after long research work and are based on the highly developed semiconductor industry test procedures and equipment. These measures help AVX to produce a consistent and high yield line of products.

#### • FINAL QUALITY INSPECTION

Finished parts are tested for standard electrical parameters and visual/mechanical characteristics. Each production lot is 100% evaluated for: capacitance and proof voltage at 2.5 U<sub>R</sub>. In addition, production is periodically evaluated for:

Average capacitance with histogram printout for capacitance distribution;  
IR and Breakdown Voltage distribution;  
Temperature Coefficient;  
Solderability;  
Dimensional, mechanical and temperature stability.

### QUALITY ASSURANCE

The reliability of these thin-film chip capacitors has been studied intensively for several years. Various measures have been taken to obtain the high reliability required today by the industry. Quality assurance policy is based on well established international industry standards. The reliability of the capacitors is determined by accelerated testing under the following conditions:

Life (Endurance)	125°C, 2U <sub>R</sub> , 1000 hours
Accelerated Damp Heat Steady State	85°C, 85% RH, U <sub>R</sub> , 1000 hours.



## Performance Characteristics RF Power Applications

### RF POWER APPLICATIONS

In RF power applications capacitor losses generate heat. Two factors of particular importance to designers are:

- Minimizing the generation of heat.
- Dissipating heat as efficiently as possible.

### CAPACITOR HEATING

- The major source of heat generation in a capacitor in RF power applications is a function of RF current (I) and ESR, from the relationship:

$$\text{Power dissipation} = I_{\text{RMS}}^2 \times \text{ESR}$$

- Accu-P® capacitors are specially designed to minimize

ESR and therefore RF heating. Values of ESR for Accu-P® capacitors are significantly less than those of ceramic MLC components currently available.

### HEAT DISSIPATION

- Heat is dissipated from a capacitor through a variety of paths, but the key factor in the removal of heat is the thermal conductivity of the capacitor material.
- The higher the thermal conductivity of the capacitor, the more rapidly heat will be dissipated.
- The table below illustrates the importance of thermal conductivity to the performance of Accu-P® in power applications.



PRODUCT	MATERIAL	THERMAL CONDUCTIVITY W/mK
Accu-P® Microwave MLC	Alumina Magnesium Titanate	18.9 6.0

**Power Handling  
Accu-P® 10pF**



Data used in calculating the graph:

Thermal impedance of capacitors:

0402	17°C/W
0603	12°C/W
0805	6.5°C/W
1210	5°C/W

Thermal impedance measured using RF generator, amplifier and strip-line transformer.

ESR of capacitors measured on Boonton 34A

### THERMAL IMPEDANCE

Thermal impedance of Accu-P® chips is shown below compared with the thermal impedance of Microwave MLC's.

CAPACITOR TYPE	CHIP SIZE	THERMAL IMPEDANCE (°C/W)
Accu-P®	0805	6.5
	1210	5
Microwave MLC	0505	12
	1210	7.5

The thermal impedance expresses the temperature difference in °C between chip center and termination caused by a power dissipation of 1 watt in the chip. It is expressed in °C/W.

### ADVANTAGES OF ACCU-P® IN RF POWER CIRCUITS

The optimized design of Accu-P® offers the designer of RF power circuits the following advantages:

- Reduced power losses due to the inherently low ESR of Accu-P®.
- Increased power dissipation due to the high thermal conductivity of Accu-P®.

• THE ONLY TRUE TEST OF A CAPACITOR IN ANY PARTICULAR APPLICATION IS ITS PERFORMANCE UNDER OPERATING CONDITIONS IN THE ACTUAL CIRCUIT.

### PRACTICAL APPLICATION IN RF POWER CIRCUITS

- There is a wide variety of different experimental methods for measuring the power handling performance of a capacitor in RF power circuits. Each method has its own problems and few of them exactly reproduce the conditions present in "real" circuit applications.
- Similarly, there is a very wide range of different circuit applications, all with their unique characteristics and operating conditions which cannot possibly be covered by such "theoretical" testing.

## Application Notes

### GENERAL

Accu-F® and Accu-P® SMD capacitors are designed for soldering to printed circuit boards or other substrates. The construction of the components is such that they will withstand the time/temperature profiles used in both wave and reflow soldering methods.

1

### CIRCUIT BOARD TYPE

The circuit board types which may be used with Accu-F® and Accu-P® are as follows:

Accu-F®: All flexible types of circuit boards (eg. FR-4, G-10).

Accu-P®: All flexible types of circuit boards (eg. FR-4, G-10) and also alumina.

For other circuit board materials, please consult factory.

### HANDLING

SMD capacitors should be handled with care to avoid damage or contamination from perspiration and skin oils. The use of plastic tipped tweezers or vacuum pick-ups is strongly recommended for individual components. Bulk handling should ensure that abrasion and mechanical shock are minimized. For automatic equipment, taped and reeled product gives the ideal medium for direct presentation to the placement machine.

### COMPONENT PAD DESIGN

Component pads must be designed to achieve good joints and minimize component movement during reflow soldering. Pad designs are given below for both wave and reflow soldering.

The basis of these designs is:

- Pad width equal to component width. It is permissible to decrease this to as low as 85% of component width but it is not advisable to go below this.
- Pad overlap 0.5mm beneath large components. Pad overlap about 0.3mm beneath small components.
- Pad extension of 0.5mm for reflow of large components and pad extension about 0.3mm for reflow of small components. Pad extension about 1.0mm for wave soldering.

### WAVE SOLDERING

**DIMENSIONS:** millimeters (inches)

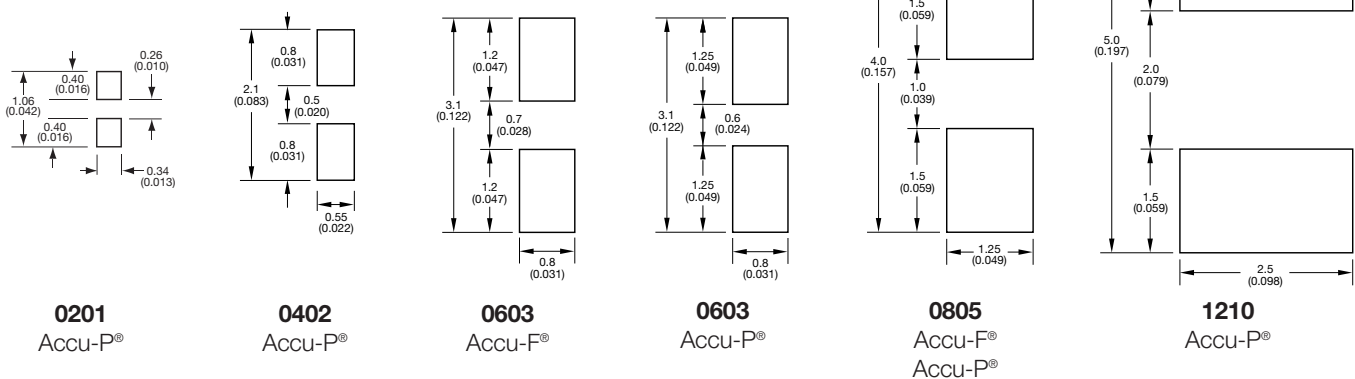

### REFLOW SOLDERING

**DIMENSIONS:** millimeters (inches)



## Application Notes

### PREHEAT & SOLDERING

The rate of preheat in production should not exceed 4°C/second and a recommended maximum is about 2°C/second. Temperature differential from preheat to soldering should not exceed 100°C.

For further specific application or process advice, please consult AVX.

### COOLING

After soldering, the assembly should preferably be allowed to cool naturally. In the event of assisted cooling, similar conditions to those recommended for preheating should be used.

### HAND SOLDERING & REWORK

Hand soldering is permissible. Preheat of the PCB to 150°C is required. The most preferable technique is to use hot air soldering tools. Where a soldering iron is used, a temperature controlled model not exceeding 30 watts should be used and set to not more than 260°C.

### CLEANING RECOMMENDATIONS

Care should be taken to ensure that the devices are thoroughly cleaned of flux residues, especially the space beneath the device. Such residues may otherwise become conductive and effectively offer a lossy bypass to the device. Various recommended cleaning conditions (which must be optimized for the flux system being used) are as follows:

Cleaning liquids. . . . . i-propanol, ethanol, acetylacetone, water and other standard PCB cleaning liquids.

Ultrasonic conditions . . power-20w/liter max.  
frequency-20kHz to 45kHz.

Temperature . . . . . 80°C maximum (if not otherwise limited by chosen solvent system).

Time . . . . . 5 minutes max.

### STORAGE CONDITIONS

Recommended storage conditions for Accu-F® and Accu-P® prior to use are as follows:

Temperature . . . . . 15°C to 35°C

Humidity . . . . . ≤65%

Air Pressure . . . . . 860mbar to 1060mbar

### RECOMMENDED SOLDERING PROFILE

#### IR REFLOW

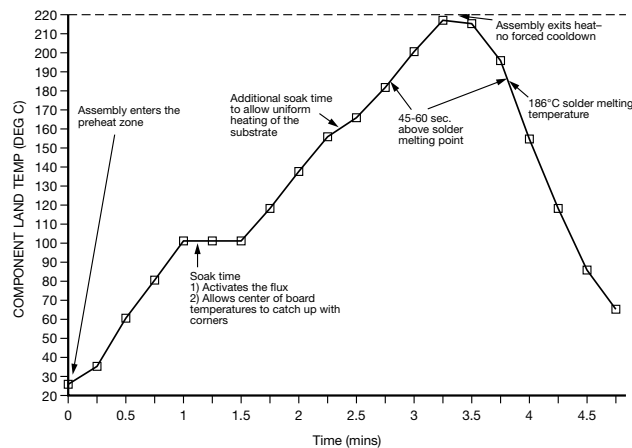

#### WAVE SOLDERING

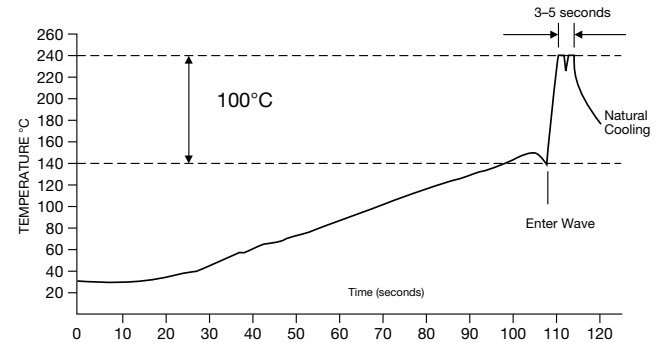

#### VAPOR PHASE

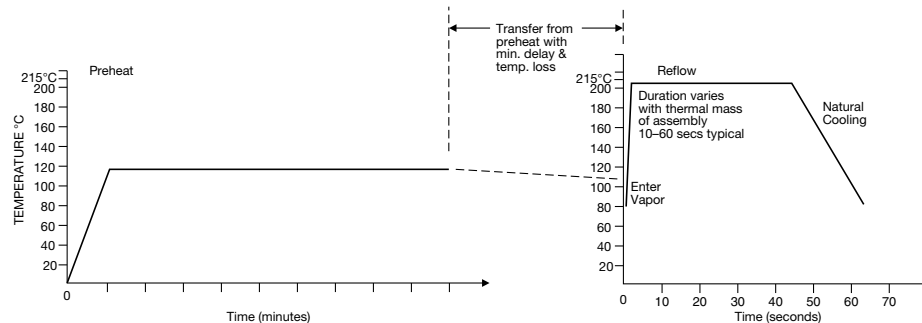

## Automatic Insertion Packaging

### TAPE & REEL

All tape and reel specifications are in compliance with EIA 481-1-A.  
(equivalent to IEC 286 part 3).

- 8mm carrier
- Reeled quantities: Reels of 3,000 per 7" reel or 10,000 pieces per 13" reel  
0201 and 0402 = 5,000 pieces per 7" reel and 20,000 pieces per 13" reel

1

### REEL

#### DIMENSIONS: millimeters (inches)

A <sup>(1)</sup>	B	C	D	E	F	G
180±1.0 (7.087±0.039)	1.5 min. (0.059 min.)	13±0.2 (0.512 ± 0.008)	20.2 min. (0.795 min.)	50 min. (1.969 min.)	9.6±1.5 (0.370 ± 0.050)	14.4 max. (0.567 max.)

Metric dimensions will govern.  
Inch measurements rounded and for reference only.

(1) 330mm (13 inch) reels are available.

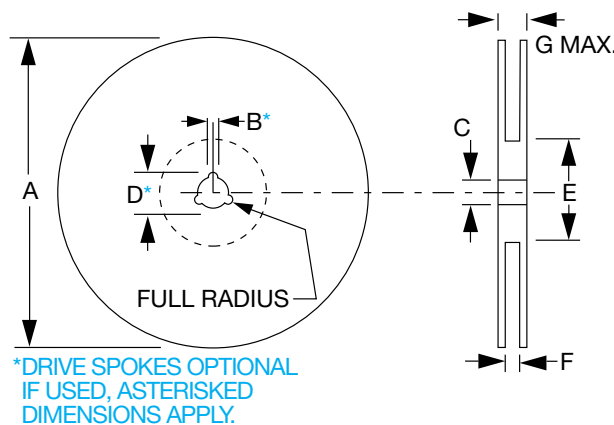

### CARRIER

#### DIMENSIONS: millimeters (inches)

A	B	C	D	E	F
8.0 ± 0.3 (0.315 ± 0.012)	3.5 ± 0.05 (0.138 ± 0.002)	1.75±0.1 (0.069 ± 0.004)	2.0 ± 0.05 (0.079 ± 0.002)	4.0 ± 0.1 (0.157 ± 0.004)	1.5 <sup>+0.1</sup> <sub>-0.0</sub> (0.059 <sup>+0.004</sup> <sub>-0.000</sub> )

NOTE: The nominal dimensions of the component compartment (W,L) are derived from the component size.



P = 4mm except 0201 and 0402 where P = 2mm

NOTE: AVX reserves the right to change the information published herein without notice.