

57F/Flat Cable Welding with Pressure Type



- Intermateable with 57family connectors.
- Highly-reliable, Scoop-Proof Cantilever Contact design.

SPECIFICATION

Voltage Rating	250V AC (r.m.s.)
Current Rating	1A/Contact
Dielectric Withstanding Voltage	500V AC (r.m.s.) for 1 minute
Insulation Resistance	1,000M Ω min. at 500V DC
Contact Resistance	35m Ω max.
Temperature range	-55°C to +105°C
Wire Accommodation	Cable Pitch 1.27mm AWG#28 (stranded and solid) AWG#30 (solid)

MATERIAL/FINISH

P/N	MATERIAL/FINISH
Insulator	PC resin (UL94V-0)/Blue
Contact	Copper alloy/Gold over Nickel Plating
Strain relife	PC resin (UL94V-0)/Blue to Stainless Steel (36, 50Pin)
Spring Latch	Stainless Steel (57F-40Type)
Metal Hood	Aluminum cast/Non-conductive paint finish (color : gray)
Plastic Hood	ABS resin/Nickel Plating
Boots	Vinyl Chloride

Rack and Panel Plug 10Type

57F-10360-20

F : Without Shield Type

NO.OF.CONTACTS
24, 36, 50

COVER SHAPE AND COLOR

O : Open end cover/Blue
A : Closed end cover/Blue

CONTACT PLATING

1 : Gold ($0.8\ \mu\text{m}$) over Nickel Plating
2 : Gold ($0.4\ \mu\text{m}$) over Nickel Plating

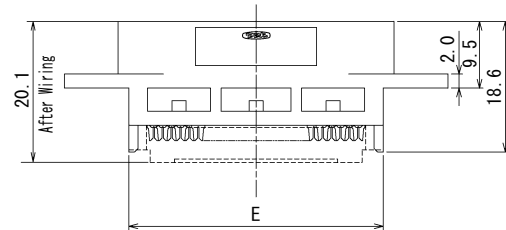
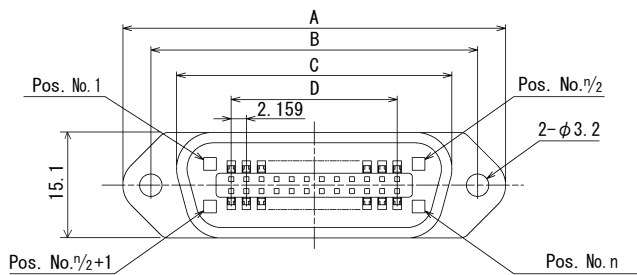

No. of Contacts	A	B	C	D	E	F
24	54.78	46.78	39.40	23.749	36.30	29.21
36	67.74	59.74	52.20	36.703	51.50	44.45
50	82.85	74.85	67.40	51.816	68.50	62.23

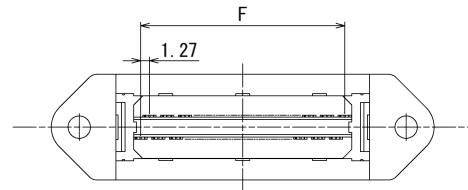

Panel Mounting Dimensions

● Connector Front mount Type

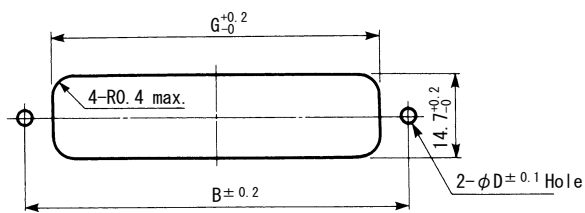

No. of Contacts	B	D	G
24	46.78	3.3	34.7
36	59.74	3.3	47.7
50	74.85	3.3	62.8

● Connector Rear mount Type

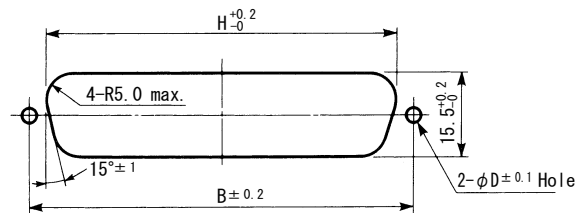

No. of Contacts	B	D	H
24	46.78	3.2	40.1
36	59.74	3.2	53.0
50	74.85	3.2	68.2

■ Plug 30Type

57F-30360-20S

F : Without Shield Type

NO.OF.CONTACTS
14, 24, 36, 50

CONTACT PLATING
1 : Gold (0.8 μm) over Nickel Plating
2 : Gold (0.4 μm) over Nickel Plating

STRAIN RELIEF

No Designation : Non strain relief
S : with plastic strain relief (Appendix)
K : with metal strain relief (Appendix)
(36 and 50 contacts only)

COVER SHAPE AND COLOR

O : Open end cover/Blue
A : Closed end cover/Blue

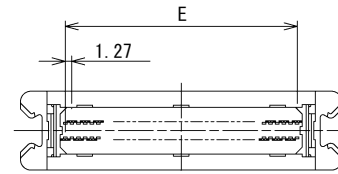
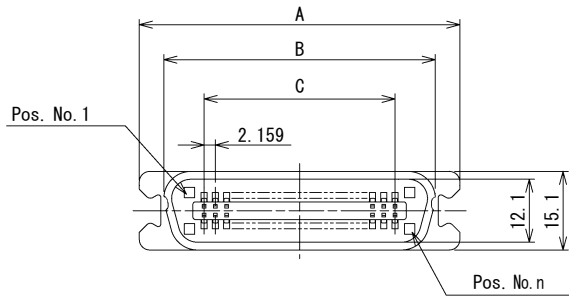

No. of Contacts	A	B	C	D	E
14	37.82	28.6	12.954	23.20	16.51
24	48.64	39.4	23.749	36.30	29.21
36	61.62	52.2	36.703	51.50	44.45
50	76.74	67.4	51.816	68.50	62.23

Shield Receptacle

57F-40360-20S

NO.OF.CONTACTS
14, 24, 36, 50

CONTACT PLATING
1 : Gold (0.8 μm) over Nickel Plating
2 : Gold (0.4 μm) over Nickel Plating

STRAIN RELIEF

No Designation : Non strain relief
S : with plastic strain relief (Appendix)
K : with metal strain relief (Appendix)
(36 and 50 contacts only)

COVER SHAPE AND COLOR

O : Open end cover/Blue
A : Closed end cover/Blue

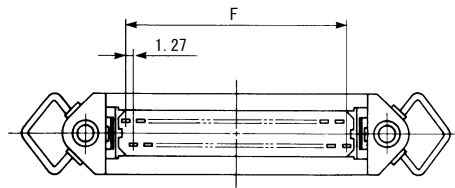
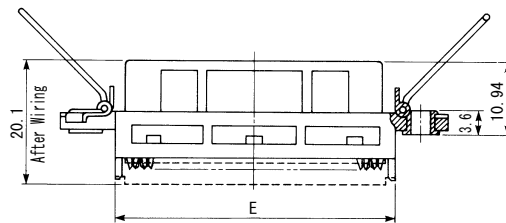

No. of Contacts	Size					
	A	B	C	D	E	F
14	44.00	36.00	25.2	12.954	23.2	16.51
24	54.78	46.78	36.1	23.749	36.3	29.21
36	67.74	59.74	48.9	36.703	51.5	44.45
50	82.85	74.85	64.0	51.816	68.5	62.23

Panel Mounting Dimensions

● Connector Front mount Type

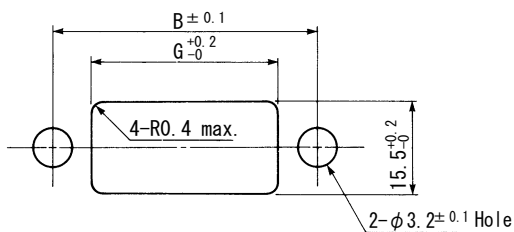

No. of Contacts	B	G	
		With out strain relief	With strain relief
14	36.00	23.7	25.6
24	46.78	36.8	38.7
36	59.74	52.0	53.9
50	74.85	69.0	70.9

● Connector Rear mount Type

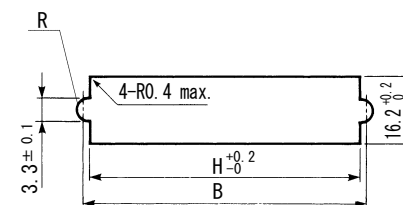

No. of Contacts	B	H
14	36.00	35.30
24	46.78	46.08
36	59.74	59.04
50	74.85	74.15

Thickness=1.6mm max.

Note : The Dimension is 16.2 Max. When Mating with 57FE-10Type Connector

■ Hood-Top Cable Entry Metal Hood

57F-□□H-3R

NO.OF.CONTACTS 14, 24, 36, 50



No. of Contacts	A	B	C	D
14	40.0	33.20	30.0	8.5
24	45.5	44.00	39.8	10.0
36	45.5	57.00	55.0	12.0
50	45.5	72.10	70.9	13.0

■ Hood-Top Cable Entry Metallized Plastic Hood

57FE-□□H-CF

NO.OF.CONTACTS 24, 36, 50

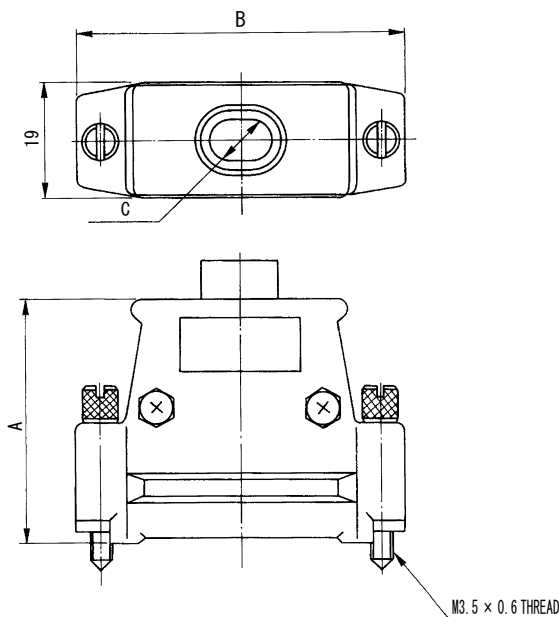

No. of Contacts	A	B	C
24	41	55	10
36	44	68	12
50	44	83	13

Unit : mm

Side Cable Entry Metal Hood

57F-50LH-3R

Connector 50 Pin only

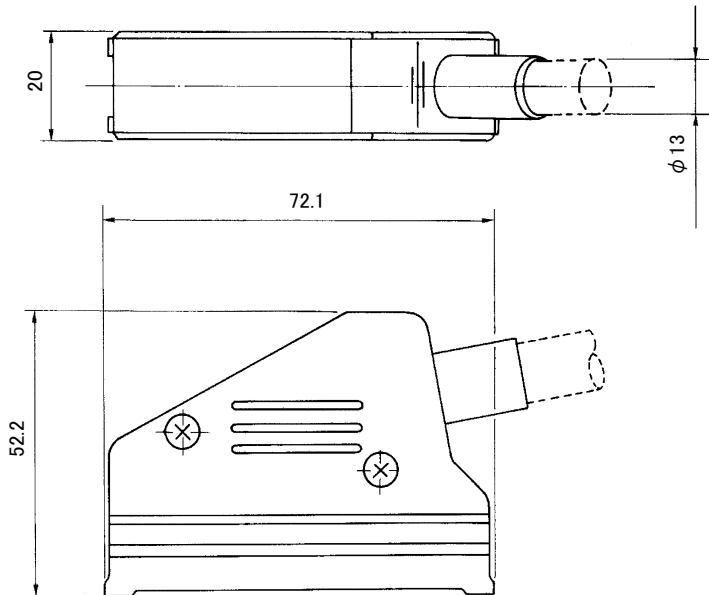

Strain Relief

Plastic Strain Relief

57F-50-041

NO.OF.CONTACTS 14, 24, 36, 50

• MATERIAL/FINISH • • Polycarbonate Resin (UL94V-O)/Blue

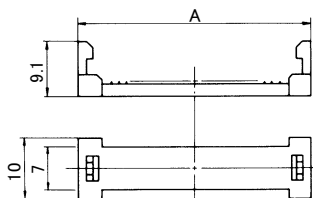

No. of Contacts	A
14	25.1
24	38.2
36	53.4
50	70.4

Wiring Tool

- Cable Cutting Tool : 357J-4256
- Press-Fitting Tool : 357J-4674D Attachment 357J-4668