

C&K 7000 Series Rocker and Lever Handle Switches



Features/Benefits

- Multi-pole and multi-position
- Wide variety of actuator and termination options
- Epoxy sealed terminals prevent contamination during soldering

Typical Applications

- Telecommunications
- Instrumentation
- Medical equipment

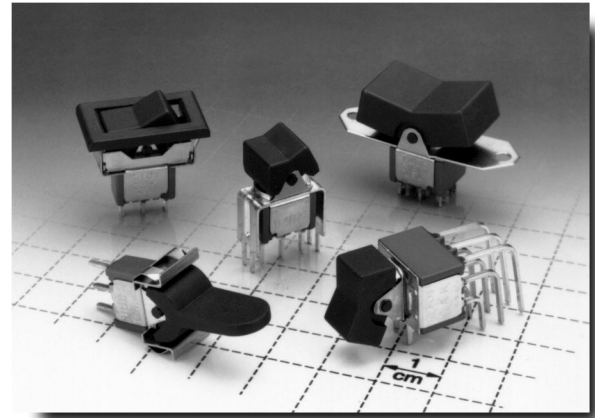

Build-A-Switch

Our easy Build-A-Switch concept allows you to mix and match options to create the switch you need. Below is a complete listing of options shown in catalog. To order, simply select desired option from each category and place in the appropriate box. Switches with standard options are shown on pages F-4 and F-5. Available options are shown and described on pages F-6 thru F-22. For additional options not shown in catalog, consult Customer Service Center. All models have epoxy terminal seal and are compatible with all "bottom-wash" PCB cleaning methods.

Typical Example: 7 1 0 1 — J 1 — Z — Q — E — 2 —

Switch Function

- 7101** (STD.) SP On-None-On
- 7103** (STD.) SP On-Off-On
- 7201** (STD.) DP On-None-On
- 7301** (STD.) 3P On-None-On
- 7401** (STD.) 4P On-None-On
- 7105** SP Mom.-Off-Mom.
- 7107** SP On-Off-Mom.
- 7108** SP On-None-Mom.
- 7109** SP None-On-Mom.
- 7203** DP On-Off-On
- 7205** DP Mom.-Off-Mom.
- 7207** DP On-Off-Mom.
- 7208** DP On-None-Mom.
- 7209** DP None-On-Mom.
- 7211** DP On-On-On
- 7213** DP On-On-Mom.
- 7215** DP Mom.-On-Mom.
- 7303** 3P On-Off-On
- 7305** 3P Mom.-Off-Mom.
- 7307** 3P On-Off-Mom.
- 7308** 3P On-None-Mom.
- 7309** 3P None-On-Mom.
- 7403** 4P On-Off-On
- 7405** 4P Mom.-Off-Mom.
- 7407** 4P On-Off-Mom.
- 7408** 4P On-None-Mom.
- 7409** 4P None-On-Mom.
- 7411** 4P On-On-On
- 7413** 4P On-On-Mom.
- 7415** 4P Mom.-On-Mom.

Note: UL/CSA models available, see page F-6.

Actuator

- J1** (STD.) Rocker
- J2** Lever
- J3** Rocker
- J8** Rocker
- J10** Rocker
- J11** Rocker with frame
- J15** Rocker with frame, snap-in
- J16** Rocker, snap-in
- J19** Rocker with frame
- J21** Lever with frame
- J25** Lever, snap-in
- J26** Lever with frame, snap-in
- J37** Rocker with frame
- J50** Rocker
- J51** Rocker with frame
- J52** Rocker with frame & LED, snap-in
- J53** Rocker, snap-in
- J60** Lever
- J61** Lever with frame, snap-in
- J62** Lever with frame & LED, snap-in
- J63** Lever, snap-in
- J76** Rocker with frame, snap-in
- J90** Lever
- J91** Lever with frame, snap-in
- J92** Lever with frame & LED, snap-in
- J93** Lever, snap-in

Terminations

- A** (STD.) Right angle, PC thru-hole
- AV2** (STD.) Vertical right angle, PC thru-hole
- C** (STD.) PC Thru-hole
- Z** (STD.) Solder lug
- A3** Right angle, snap-in, PC thru-hole
- AV3** Vertical right angle, snap-in, PC thru-hole
- AW** Right angle, extended, PC thru-hole
- AW1** Right angle, extended, PC thru-hole
- AW3** Right angle, extended, PC thru-hole
- AW4** Right angle, extended, PC thru-hole
- V2** .555" high, V-bracket
- V3** .460" high, V-bracket
- V4** .630" high, V-bracket
- V5** Vertical right angle, PC thru-hole
- V6** .460" high, V-bracket
- V7** .630" high, V-bracket
- V8** .953" high, V-bracket
- V9** 1.150" high, V-bracket
- V21** .555" high, V-bracket, snap-in
- V31** .460" high, V-bracket, snap-in
- V41** .630" high, V-bracket, snap-in
- V51** Vertical right angle, snap-in
- V54** Vertical right angle, extended
- V55** Vertical right angle, extended
- V61** .460" high, V-bracket, snap-in
- V71** .630" high, V-bracket, snap-in
- V81** .953" high, V-bracket, snap-in
- V91** 1.150" high, V-bracket, snap-in

Contact Material

- B** (STD.) Gold
- Q** (STD.) Silver
- K** Gold
- M** Silver
- G** Gold over silver
- L** Gold over silver

Seal

- E** (STD.) Epoxy
- I** Epoxy potted base

Actuator Color

- 2** (STD.) Black
- 1** White
- 3** Red

Frame Color

- 2** (STD.) Black
- NONE** No frame color required
- 1** White
- 3** Red

Metal Frame Color (J11, J19, J21, J37 Actuators)

- 2** (STD.) Black
- 1** White
- C** Bright chrome
- S** Satin chrome

- W** .750" long, wire wrap
- W1** .964" long, wire wrap
- W3** .425" long, wire wrap
- W4** 1.062" long, wire wrap
- W5** 1.305" long, wire wrap
- Z3** Quick connect



F

Rocker

C&K 7000 Series Rocker and Lever Handle Switches

Specifications

CONTACT RATING: B contact material: 0.4 VA max. @ 20 V AC or DC max. Q contact material: 5 AMPS @ 120 V AC or 28 V DC; 2 AMPS @ 250 V AC. See page F-22 for additional ratings.

ELECTRICAL LIFE: 7X01 and UX1 models: 100,000 make-and-break cycles at full load. All other models: 40,000 cycles.

CONTACT RESISTANCE: Below 10 milliohms typ. initial @ 2-4 V DC, 100 mA, for both silver and gold plated contacts.

INSULATION RESISTANCE: 10^9 ohms min.

DIELECTRIC STRENGTH: 1000 V RMS min. @ sea level.

OPERATING TEMPERATURE: -30°C to 85°C .

SOLDERABILITY: Per MIL-STD-202F method 208D, or EIA RS-186E method 9 (1 hour steam aging).

NOTE: Specifications and materials listed above are for switches with standard options. For information on specific and custom switches, consult Customer Service Center.

Materials

CASE: Glass filled nylon 6/6, flame retardant, heat stabilized, or diallyl phthalate (DAP) (UL 94V-0).

ACTUATOR: Nylon, black.

FRAME (FRONT MOUNT): Nylon, black.

FRAME (REAR MOUNT): Spring steel, black.

BUSHING: Brass or zinc, nickel plated.

HOUSING: Stainless steel.

SWITCH SUPPORT: Brass or steel, tin plated.

END CONTACTS: B contact material: Copper alloy, with gold plate over nickel plate. Q contact material: Coin silver, silver plated. See page F-22 for additional contact materials.

CENTER CONTACTS & ALL TERMINALS: B contact material: Copper alloy, with gold plate over nickel plate. Q contact material: Copper alloy, silver plated. See page F-22 for additional contact materials.

TERMINAL SEAL: Epoxy.

HARDWARE: Mounting nuts & screws: Brass. Lockwasher: Stainless steel. Standoff: Nylon standard, aluminum available, consult Customer Service Center.

SWITCHES WITH STANDARD OPTIONS

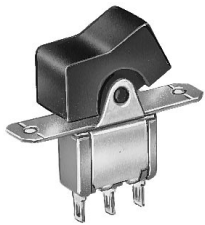

7101J1ZQE2
SPDT

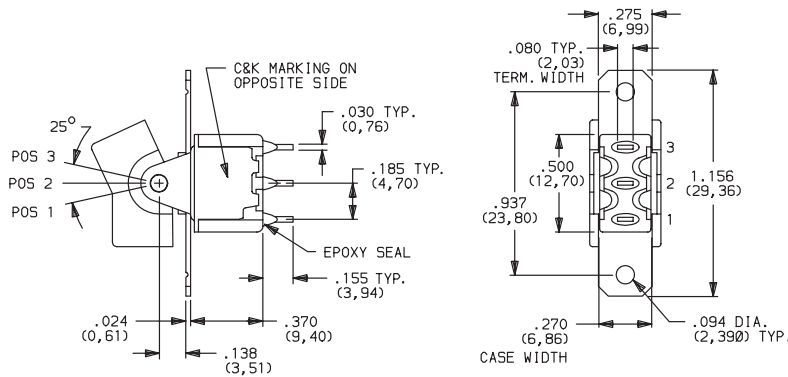

	POS. 1	POS. 2	POS. 3
PART NUMBER			
7101J1ZQE2	ON	NONE	ON

NOTE: For PC termination, replace 'Z' with 'C'. For panel mounting information, see page F-7.

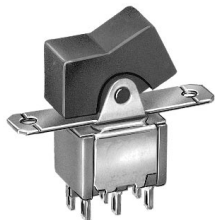

7201J1ZQE2
DPDT

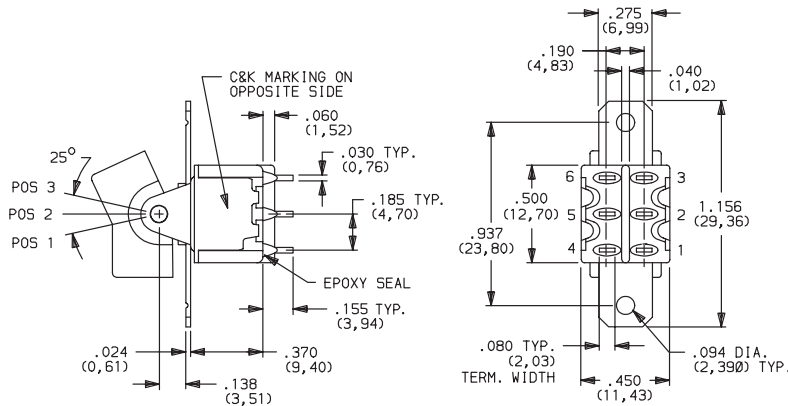

	POS. 1	POS. 2	POS. 3
PART NUMBER			
7201J1ZQE2	ON	NONE	ON

NOTE: For PC termination, replace 'Z' with 'C'. For panel mounting information, see page F-7.

C&K 7000 Series Rocker and Lever Handle Switches

SWITCHES WITH STANDARD OPTIONS

PART NUMBER	POS. 1	POS. 2	POS. 3
7301J1ZQE2	ON	NONE	ON

NOTE: For PC termination, replace 'Z' with 'C'.
For panel mounting information, see page F-7.

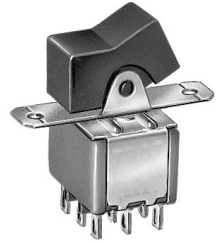
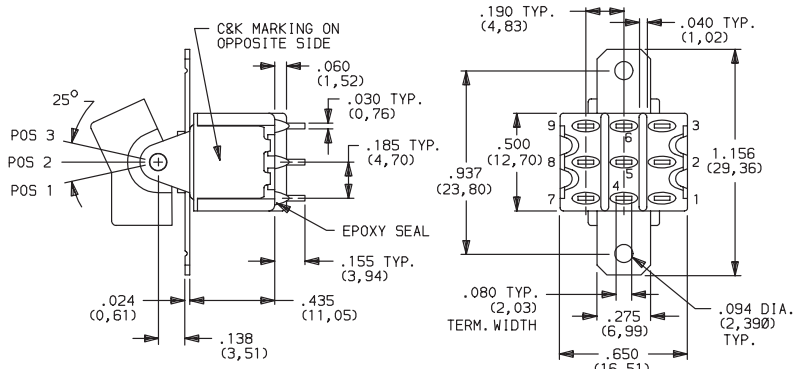

7301J1ZQE2
3PDT

PART NUMBER	POS. 1	POS. 2	POS. 3
7401J1ZQE2	ON	NONE	ON

NOTE: For PC termination, replace 'Z' with 'C'.
For panel mounting information, see page F-7.

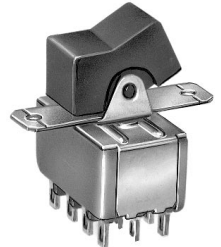
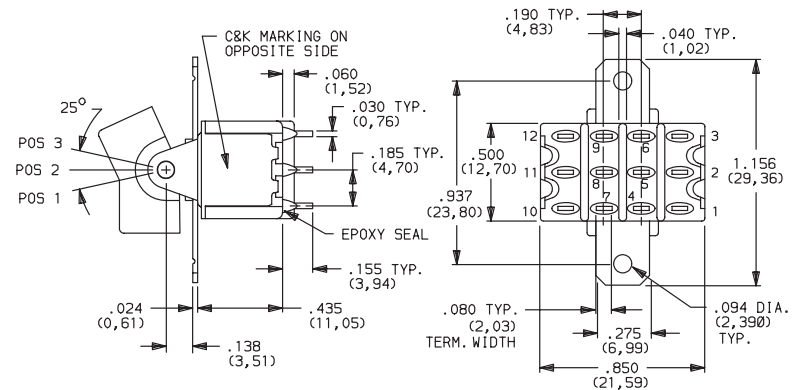

7401J1ZQE2
4PDT

PART NUMBER	POS. 1	POS. 2	POS. 3
7101J1ABE2	ON	NONE	ON
7101J1AQE2	ON	NONE	OFF
7103J1ABE2	ON	OFF	ON

NOTE: For PC mounting information, see page F-15.

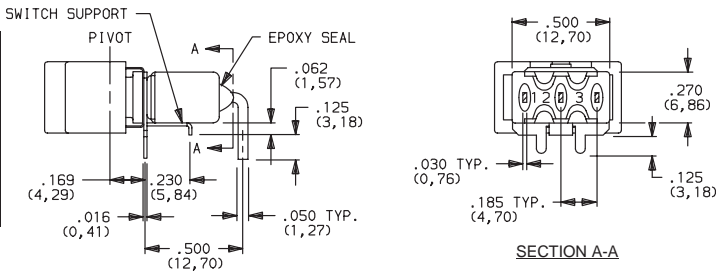

7101J1ABE2
Horizontal Actuation
SPDT

PART NUMBER	POS. 1	POS. 2	POS. 3
7301J1AV2QE2	ON	NONE	ON

NOTE: For PC mounting information, see page F-17.

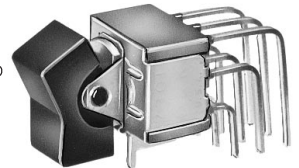
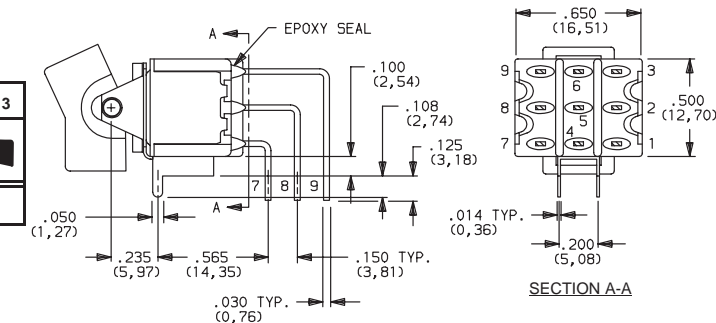

7301J1AV2QE2
Vertical Actuation
3PDT





F

Rocker

C&K 7000 Series Rocker and Lever Handle Switches

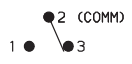
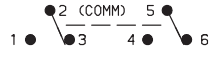
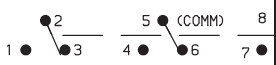
SWITCH FUNCTION

NO. POLES	MODEL NO.	UL/CSA** MODEL NO.	SWITCH FUNCTION			CONNECTED TERMINALS			SCHEMATIC
			POS. 1	POS. 2	POS. 3	POS. 1	POS. 2	POS. 3	
SP	7101 (STD.)	U11	ON	NONE	ON				
	7103 (STD.)	U13	ON	OFF	ON				
	7105	U15	MOM.	OFF	MOM.	2-3	OPEN	2-1	
	7107	U17	ON	OFF	MOM.				
	7108	U18	ON	NONE	MOM.				
	7109	U19	NONE	ON	MOM.	N/A	2-3	2-1	
DP	7201 (STD.)	U21	ON	NONE	ON				
	7203	U23	ON	OFF	ON				
	7205	U25	MOM.	OFF	MOM.	2-3,5-6	OPEN	2-1,5-4	
	7207	U27	ON	OFF	MOM.				
	7208	U28	ON	NONE	MOM.				
	7209	U29	NONE	ON	MOM.	N/A	2-3,5-6	2-1,5-4	
	7211*	U211*	ON	ON	ON				
	7213*	U213*	ON	ON	MOM.	2-3,5-6	2-3,5-4	2-1,5-4	
7215*	U215*	MOM.	ON	MOM.				DPDT	
3P	7301 (STD.)	U31	ON	NONE	ON				
	7303	U33	ON	OFF	ON				
	7305	U35	MOM.	OFF	MOM.	2-3,5-6,8-9	OPEN	2-1,5-4,8-7	
	7307	U37	ON	OFF	MOM.				
	7308	U38	ON	NONE	MOM.				
	7309	U39	NONE	ON	MOM.	N/A	2-3,5-6,8-9	2-1,5-4,8-7	
4P	7401 (STD.)	U41	ON	NONE	ON				
	7403	U43	ON	OFF	ON				
	7405	U45	MOM.	OFF	MOM.	2-3,5-6,8-9,11-12	OPEN	2-1,5-4,8-7,11-10	
	7407	U47	ON	OFF	MOM.				
	7408	U48	ON	NONE	MOM.				
	7409	U49	NONE	ON	MOM.	N/A	2-3,5-6,8-9,11-12	2-1,5-4,8-7,11-10	
	7411*	U411*	ON	ON	ON				
	7413*	U413*	ON	ON	MOM.	2-3,5-6,8-9,11-12	2-3,5-4,8-9,11-10	2-1,5-4,8-7,11-10	
7415*	U415*	MOM.	ON	MOM.				4PDT	

MOM. = Momentary

* Wiring for 3-way switch, see page L-29.

**U11-U415 model nos. with all options when ordered with G, L, M or Q contact material.



Rocker

C&K 7000 Series Rocker and Lever Handle Switches

ACTUATOR—PANEL REAR MOUNT

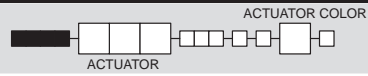

OPTION CODE	ACTUATOR COLOR
2	(STD.) BLACK
1	WHITE
3	RED

Finish: Matte. Other colors, custom actuator markings and legends available, consult Customer Service Center.

NOTE: Hardware: two each—mounting screws, nuts, lockwashers and standoffs for 1/8 inch thick panel are supplied standard on all switches with panel mounting brackets. Hardware is available separately, see section L.

J1, J2, J3, J8 & J10 Actuators available with C, W-W5, Z or Z3 terminations.

PANEL MOUNTING

J1 & J2 Actuators

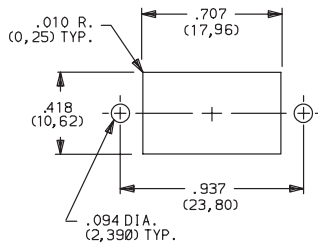

J3 Actuator

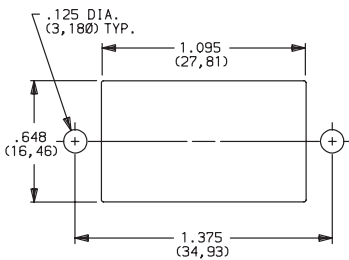

J8 Actuator

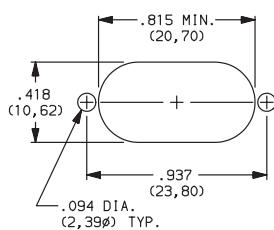

J10 Actuator

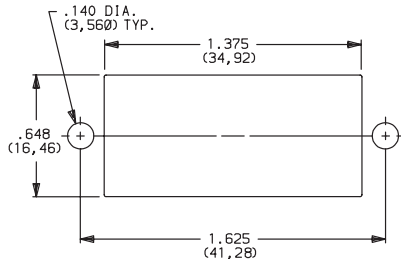

J1 (STD.) ROCKER

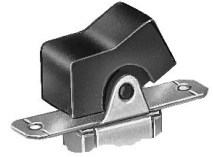
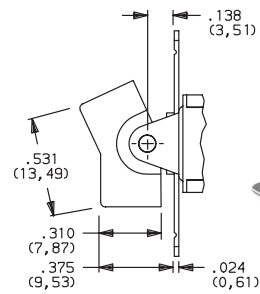
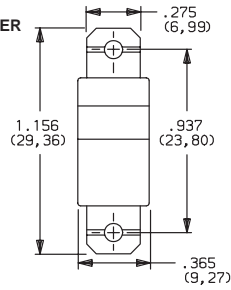

J2 LEVER

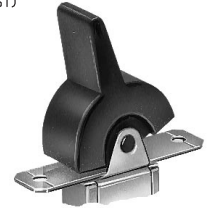
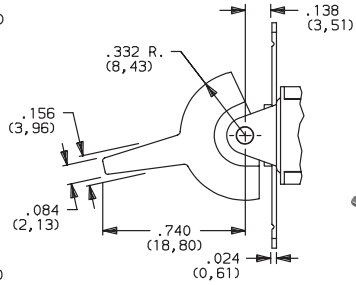
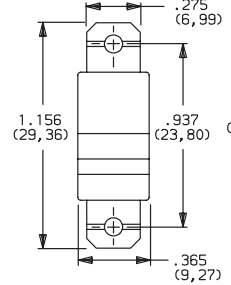

J3 ROCKER

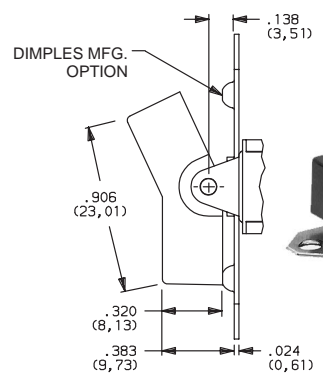
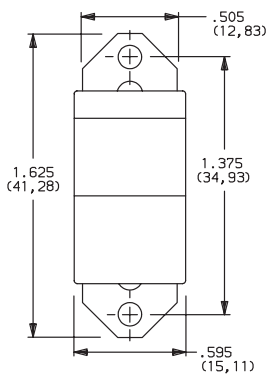

J8 ROCKER

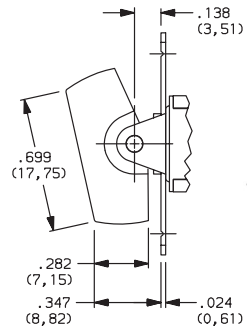
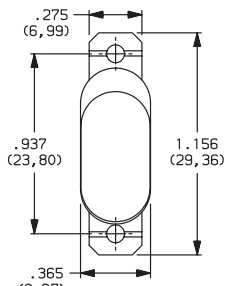

J10 ROCKER

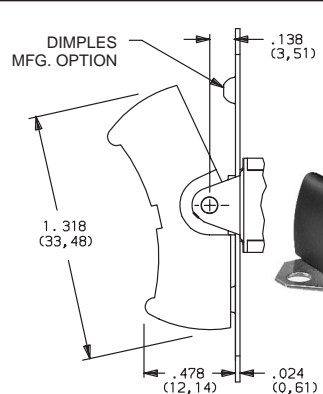
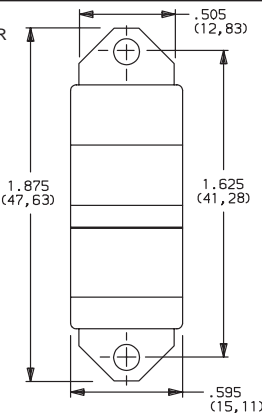

C&K 7000 Series Rocker and Lever Handle Switches

ACTUATOR—SNAP-IN FRONT MOUNT

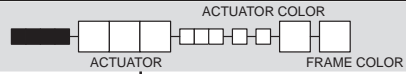

J15 ROCKER WITH FRAME, SNAP-IN

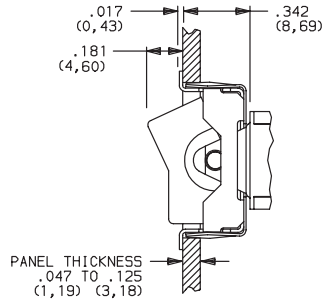
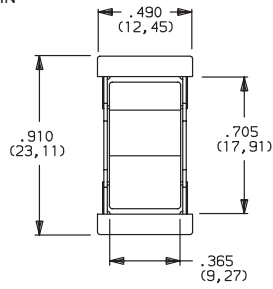

No frame color choice required.

J16 ROCKER, SNAP-IN

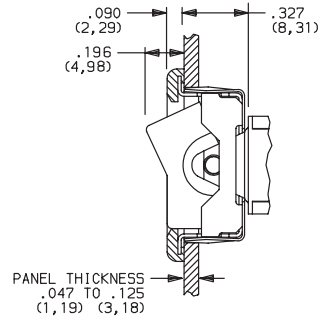
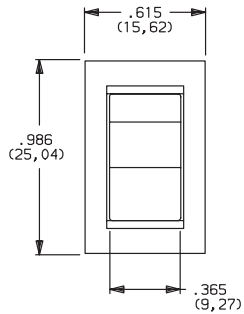

OPTION CODE	ACTUATOR COLOR
2	(STD.) BLACK
1	WHITE
3	RED

OPTION CODE	FRAME COLOR
2	(STD.) BLACK
NONE	No Frame Color (J15 or J25 options)
1	WHITE
3	RED

Finish: Matte. Other colors, custom actuator markings and legends available, consult Customer Service Center.

NOTE: Frames are available separately, see section L. J15, J16, J25, J26 & J76 Actuators available with 71XX, 72XX, U1XX & U2XX models and C, W-W5, Z and Z3 terminations.

J25 LEVER, SNAP-IN

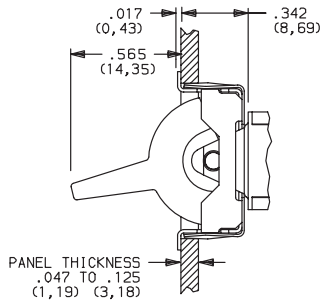
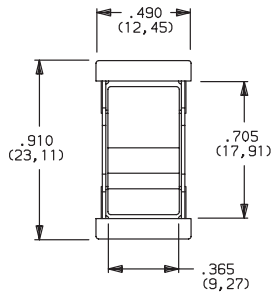
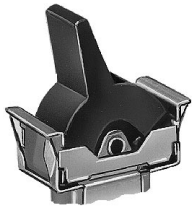

No frame color choice required.

J26 LEVER WITH FRAME, SNAP-IN

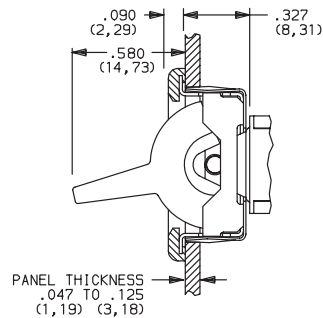
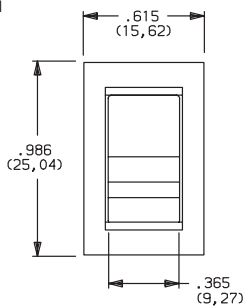

PANEL MOUNTING

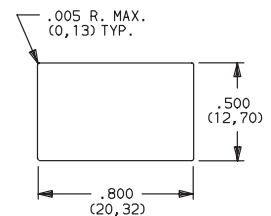

J76 ROCKER WITH FRAME, SNAP-IN

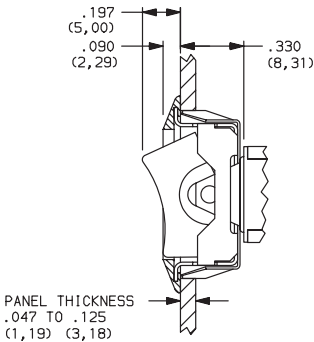
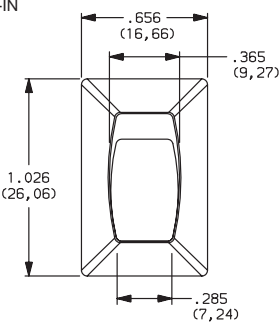

F

Rocker

C&K 7000 Series Rocker and Lever Handle Switches

ACTUATOR—SNAP-IN FRONT MOUNT

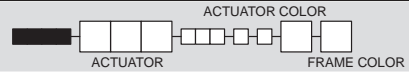

OPTION CODE	ACTUATOR COLOR
2	(STD.) BLACK
1	WHITE
3	RED

OPTION CODE	FRAME COLOR
2	(STD.) BLACK
NONE	No Frame Color (J50 or J53 options)
1	WHITE
3	RED

Finish: Matte. Other colors, custom actuator markings and legends available, consult Customer Service Center.

NOTE: Frames are available separately, see section L. J50, J51, J52 & J53 Actuators available with 71XX, 72XX, U1XX & U2XX models and C, W-W5, Z and Z3 terminations.

PANEL MOUNTING

J50, J51 & J53 Actuators

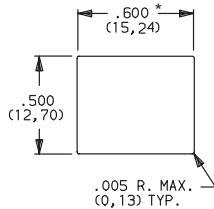

J52 Actuator

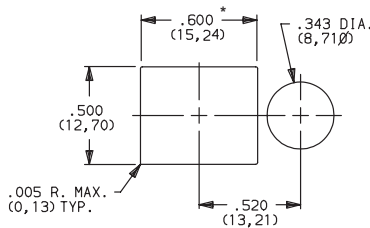

* For J50: Increase this dimension to .620/.625 (15,75/15,88) for .091/.125 (2,31/3,18) thk. panels.
For J51, J52: Increase this dimension to .620/.625 (15,75/15,88) for .060/.125 (1,52/3,18) thk. panels.

J50 ROCKER, SNAP-IN

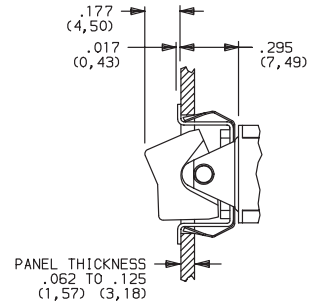
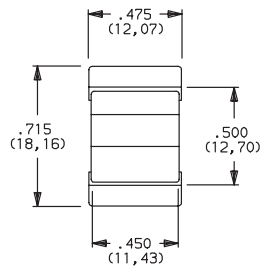

No frame color choice required.

J51 ROCKER WITH FRAME, SNAP-IN

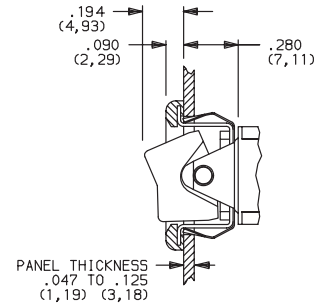
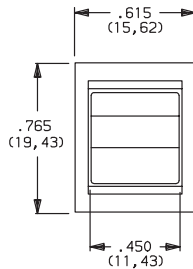

J52 ROCKER WITH FRAME & LED, SNAP-IN

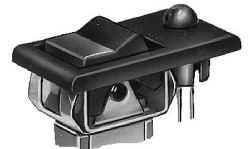
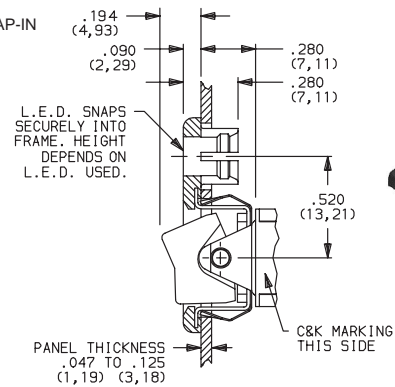
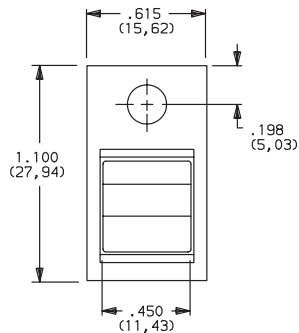

LED not included.
For LED information, see page L-30.

J53 ROCKER, SNAP-IN

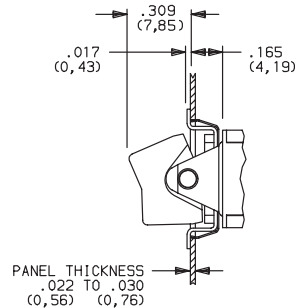
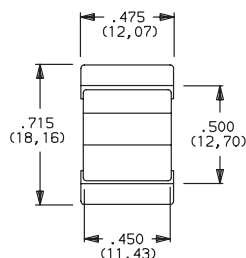

No frame color choice required.



F

Rocker

C&K 7000 Series Rocker and Lever Handle Switches

ACTUATOR—SNAP-IN FRONT MOUNT

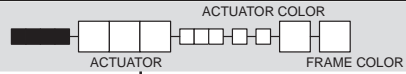

J60 LEVER, SNAP-IN

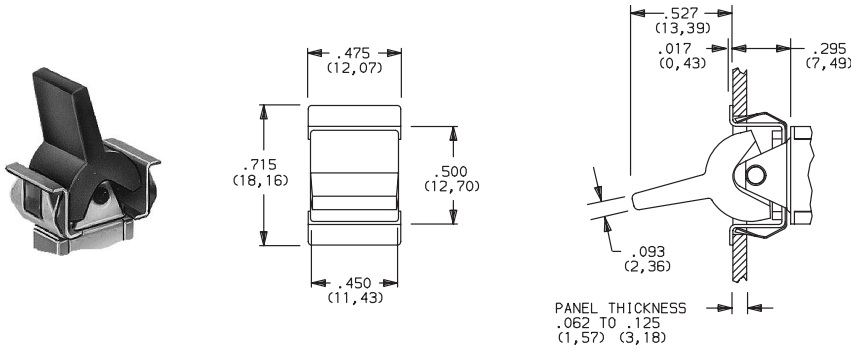

No frame color choice required.

OPTION CODE	ACTUATOR COLORS
2	(STD.) BLACK
1	WHITE
3	RED

J61 LEVER WITH FRAME, SNAP-IN

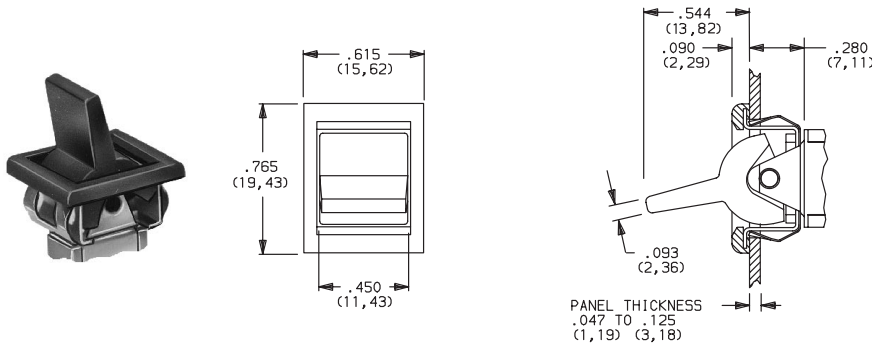

OPTION CODE	FRAME COLORS
2	(STD.) BLACK
NONE	No Frame Color (J60 or J63 options)
1	WHITE
3	RED

Finish: Matte. Other colors, custom actuator markings and legends available, consult Customer Service Center.

NOTE: Frames are available separately, see section L. J60, J61, J62 & J63 Actuators available with 71XX, 72XX, U1XX & U2XX models and C, W-W5, Z & Z3 terminations.

J62 LEVER WITH FRAME & LED, SNAP-IN

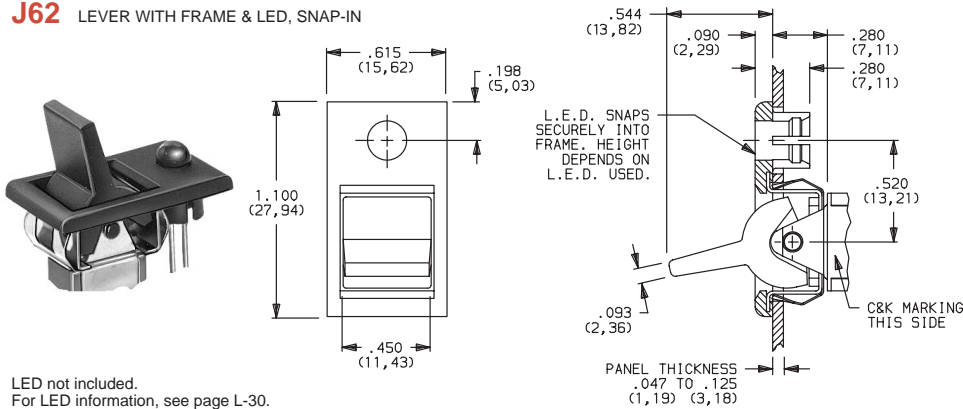

LED not included. For LED information, see page L-30.

PANEL MOUNTING

J60, J61 & J63 Actuators

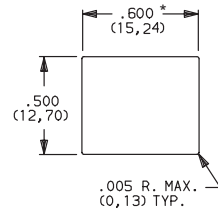

J62 Actuator

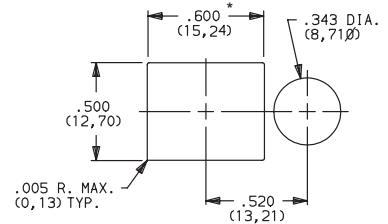

J63 LEVER, SNAP-IN

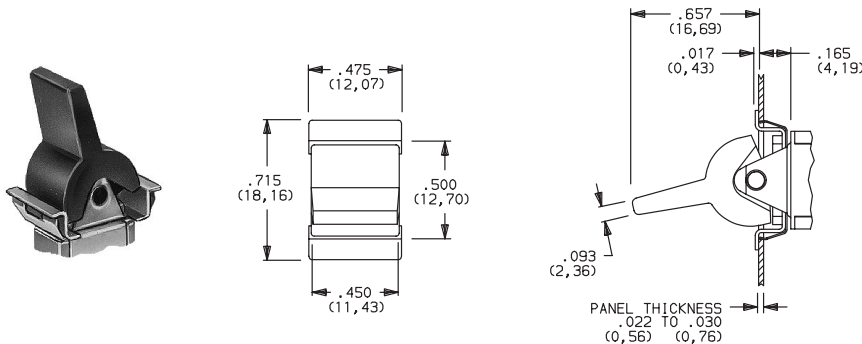

No frame color choice required.

* For J60: Increase this dimension to .620/.625 (15,75/15,88) for .091/.125 (2,31/3,18) thk. panels. For J61, J62: Increase this dimension to .620/.625 (15,75/15,88) for .060/.125 (1,52/3,18) thk. panels.



C&K 7000 Series Rocker and Lever Handle Switches

ACTUATOR—SNAP-IN FRONT MOUNT

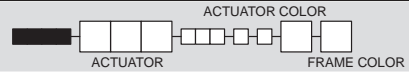

OPTION CODE	ACTUATOR COLOR
2	(STD.) BLACK
1	WHITE
3	RED

OPTION CODE	FRAME COLOR
2	(STD.) BLACK
NONE	No Frame Color (J90 or J93 options)
1	WHITE
3	RED

Finish: Matte. Other colors, custom actuator markings and legends available, consult Customer Service Center.

NOTE: Frames are available separately, see section L. J90, J91, J92 & J93 Actuators available with 71XX, 72XX, U1XX & U2XX models and C, W-W5, Z & Z3 terminations.

PANEL MOUNTING

J90, J91 & J93 Actuators

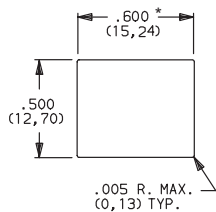

J92 Actuator

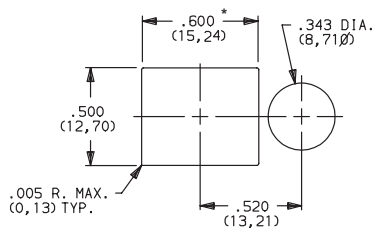

* For J90: Increase this dimension to .620/.625 (15,75/15,88) for .091/.125 (2,31/3,18) thk. panels.
For J91, J92: Increase this dimension to .620/.625 (15,75/15,88) for .060/.125 (1,52/3,18) thk. panels.

J90 LEVER, SNAP-IN

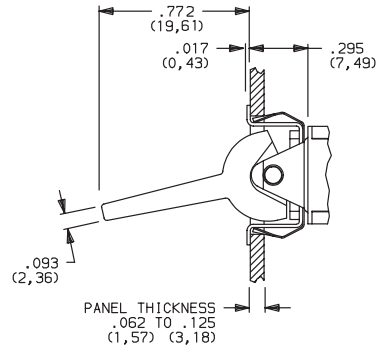
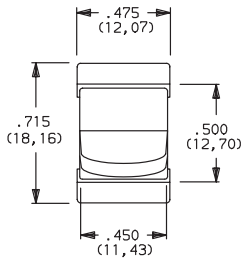

No frame color choice required.

J91 LEVER WITH FRAME, SNAP-IN

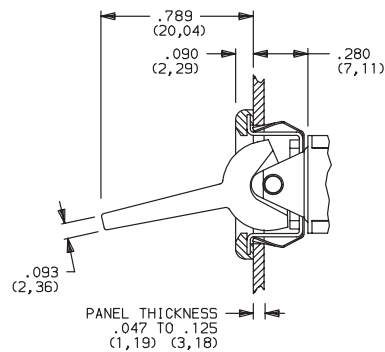
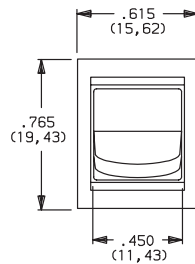

J92 LEVER WITH FRAME & LED, SNAP-IN

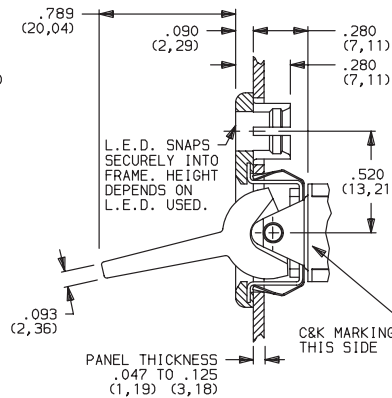
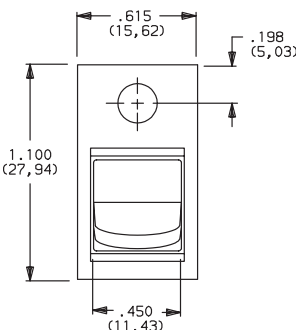

LED not included.
For LED information, see page L-30.

J93 LEVER, SNAP-IN

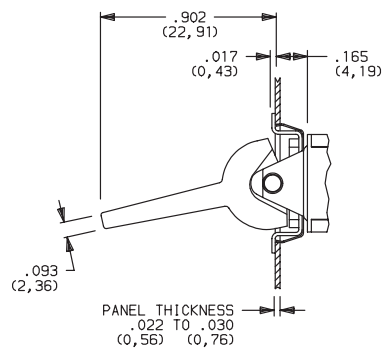
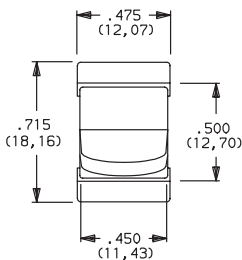

No frame color choice required.

C&K 7000 Series Rocker and Lever Handle Switches

ACTUATOR—REAR MOUNT

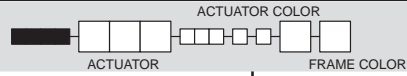

J11 ROCKER WITH FRAME

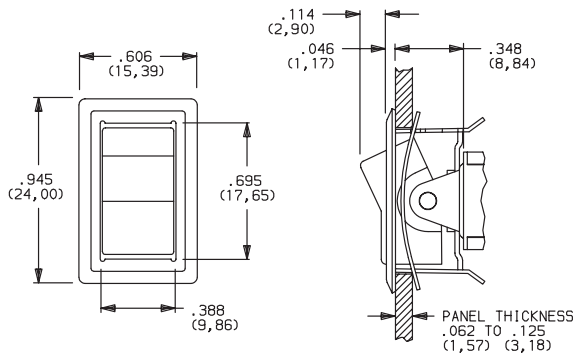

OPTION CODE	ACTUATOR COLOR
2	(STD.) BLACK
1	WHITE
3	RED

J21 LEVER WITH FRAME

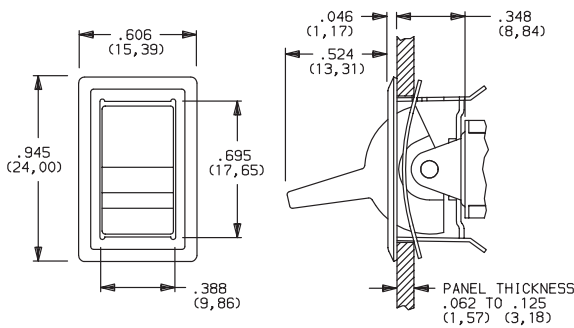

OPTION CODE	FRAME COLOR
2	(STD.) BLACK
1	WHITE
C	BRIGHT CHROME
S	SATIN CHROME

Actuator finish: Matte. Frame finish: Gloss. Other colors, custom actuator markings and legends available, consult Customer Service Center.

NOTE: Frames are available separately, see section L. J11, J19, J21 & J37 Actuators available with C, W-W5, Z & Z3 terminations.

J19 ROCKER WITH FRAME

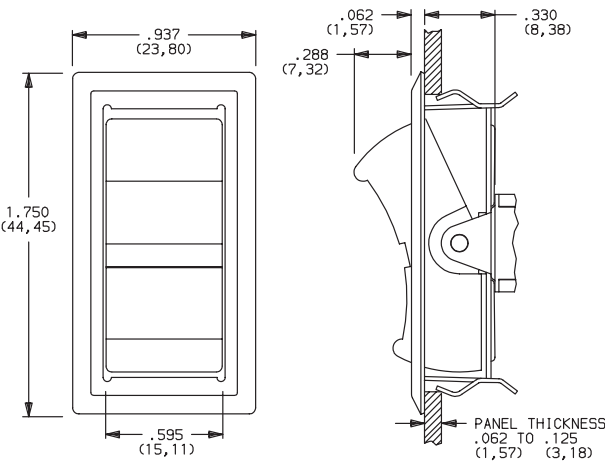

PANEL MOUNTING

J11 & J21 Actuators

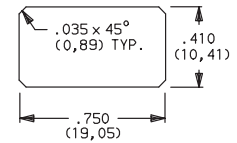

J19 Actuator

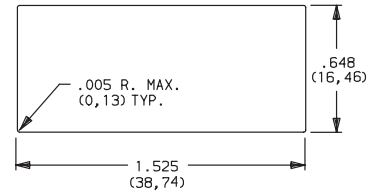

J37 ROCKER WITH FRAME

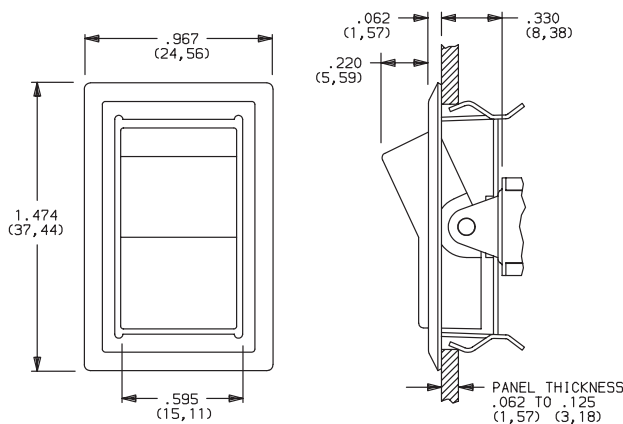

J37 Actuator

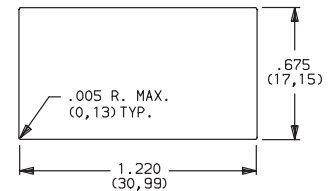

Rocker

C&K 7000 Series Rocker and Lever Handle Switches

ACTUATOR—PC MOUNT

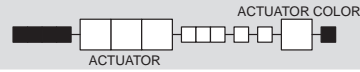

OPTION CODE	ACTUATOR COLOR
2	(STD.) BLACK
1	WHITE
3	RED

Finish: Matte. Other colors, custom actuator markings and legends available, consult Customer Service Center.

NOTE: Some permissible actuator/termination combinations may lack clearance between actuator and PC board, and care must be exercised to accommodate this condition.

Actuators are available separately, see section L. J1, J2 & J8 actuators available with A, A3, AV2, AV3, AW-AW4 & V2-V91 terminations. J3 actuators available with AV2, AV3 & V2-V91 terminations. J50 actuators available with A (DP, 3P models only), A3 (DP, 3P models only), AV2, AV3, AW-AW4 (DP, 3P models only) & V2-V91 terminations.

J1 (STD.) ROCKER

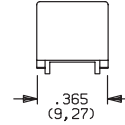
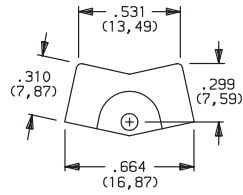

J2 LEVER

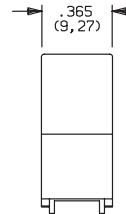
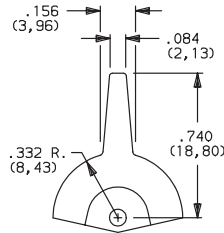

J3 ROCKER

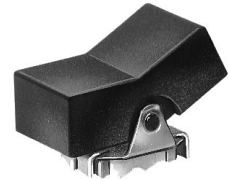
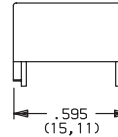
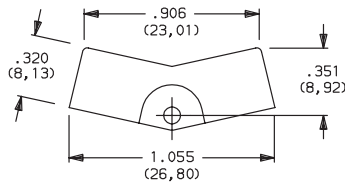

J8 ROCKER

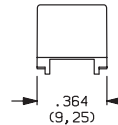
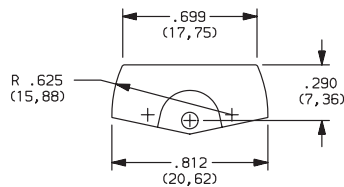

J50 ROCKER

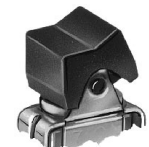
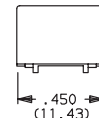
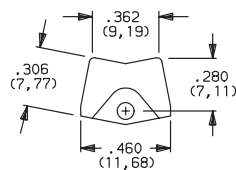

F

Rocker

C&K 7000 Series Rocker and Lever Handle Switches

ACTUATOR—PC MOUNT

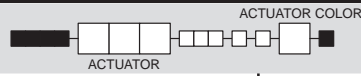

J60 LEVER

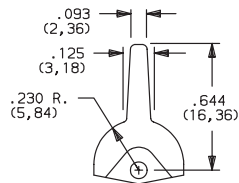

OPTION CODE	ACTUATOR COLOR
2	(STD.) BLACK
1	WHITE
3	RED

Finish: Matte. Other colors, custom actuator markings and legends available, consult Customer Service Center.

NOTE: Some permissible actuator/termination combinations may lack clearance between actuator and PC board, and care must be exercised to accommodate this condition.

Actuators are available separately, see section L. J60 & J90 actuators available with A (DP, 3P models only), A3 (DP, 3P models only), AV2, AV3, AW-AW4 (DP, 3P models only) & V2-V91 terminations.

J90 LEVER

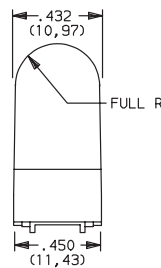
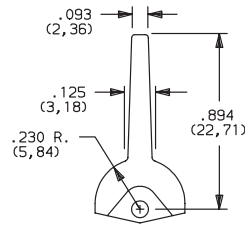

TERMINATIONS



Z (STD.) SOLDER LUG

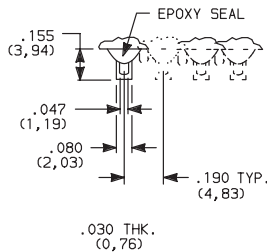

Not available with K, L or M contact materials. Available actuators, see pages F-7 thru F-14.

C (STD.) PC THRU-HOLE

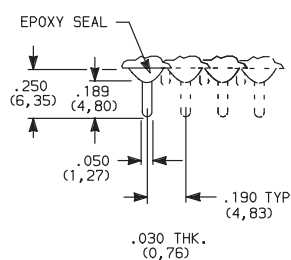

PC MOUNTING

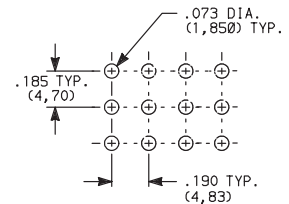

SPDT thru 4PDT

NOTE: Available actuators, see pages F-7 thru F-14.

Z3 QUICK CONNECT

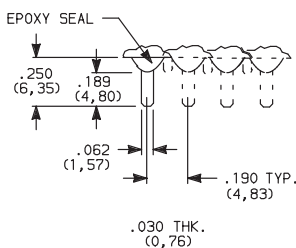

Not available with K, L or M contact materials. Available actuators, see pages F-7 thru F-14. Mating quick connector available; order part number 530100000.

W, W1, W3, W4, W5 WIRE WRAP

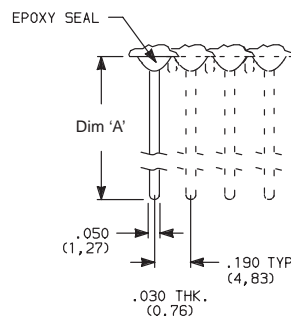

OPTION CODE	DIM 'A'
W	.750 (19,05)
W1	.964 (24,49)
W3	.425 (10,80)
W4	1.062 (26,97)
W5	1.305 (33,15)

SPDT thru 4PDT

NOTE: Available actuators, see pages F-7 thru F-14.

SPDT thru 4PDT

C&K 7000 Series Rocker and Lever Handle Switches

TERMINATIONS

A (STD.) RIGHT ANGLE, PC THRU-HOLE

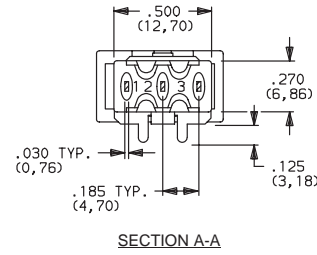
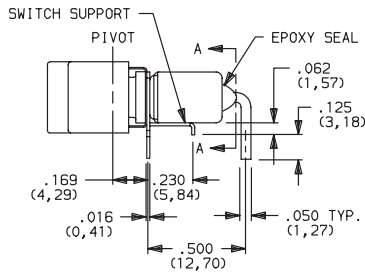
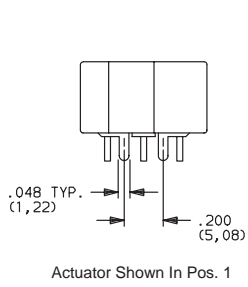

A3 RIGHT ANGLE, SNAP-IN, PC THRU-HOLE

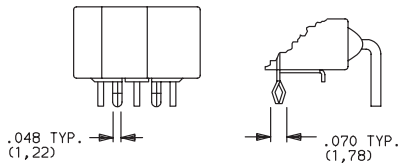

AW, AW1, AW3, AW4, AW5 RIGHT ANGLE, EXTENDED, PC THRU-HOLE

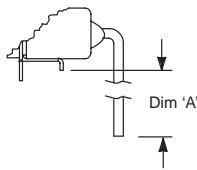

OPTION CODE	DIM 'A'
AW	.44 (11,2)
AW1	.66 (16,8)
AW3	.14 (3,6)
AW4	.77 (19,6)
AW5	1.02 (25,9)

PC MOUNTING

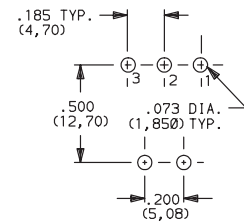

Not available with I seal option. Available actuators, see pages F-13 and F-14.
Terminal bend radii and lead-in manufacturing option.

NOTE: PC pattern must clear switch support leg.

A (STD.) RIGHT ANGLE, PC THRU-HOLE

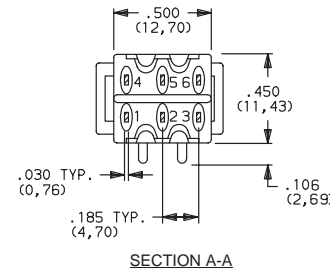
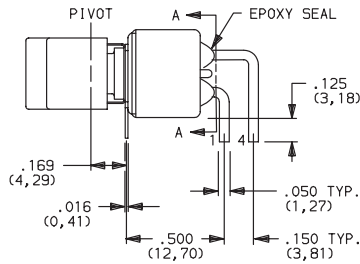
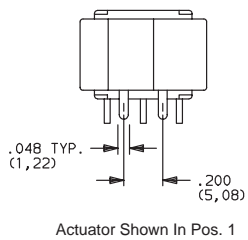

A3 RIGHT ANGLE, SNAP-IN, PC THRU-HOLE

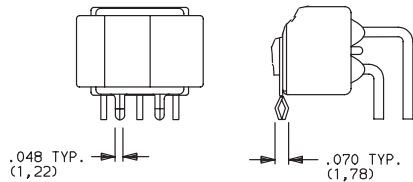

AW, AW1, AW4, AW5 RIGHT ANGLE, EXTENDED, PC THRU-HOLE

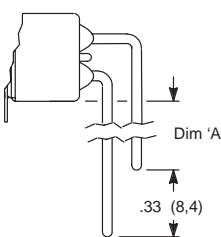

OPTION CODE	DIM 'A'
AW	.19 (4,8)
AW1	.40 (10,2)
AW4	.50 (12,7)

PC MOUNTING

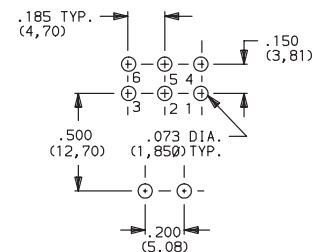

Not available with I seal option. Available actuators, see pages F-13 and F-14.
Terminal bend radii and lead-in manufacturing option.

C&K 7000 Series Rocker and Lever Handle Switches

TERMINATIONS

A (STD.) RIGHT ANGLE, PC THRU-HOLE

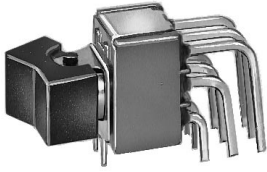

7301J1ABE2
Horizontal Actuation
3PDT

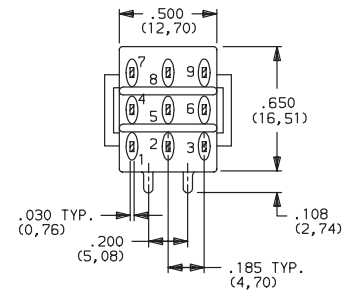
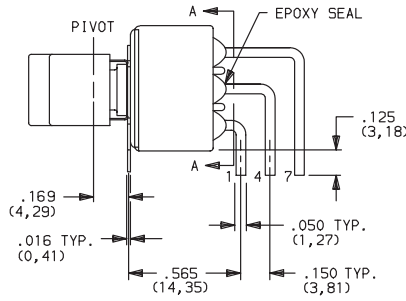
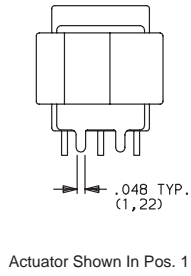

AW4 RIGHT ANGLE, EXTENDED, PC THRU-HOLE

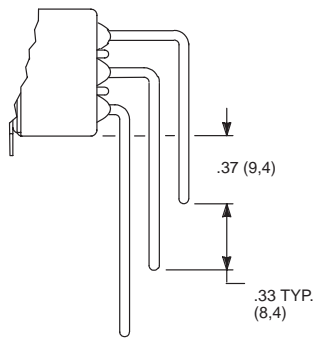

PC MOUNTING

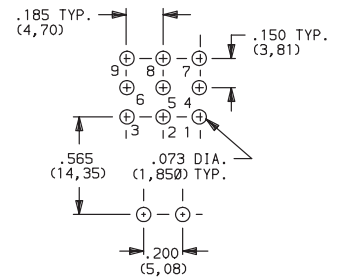

Not available with I seal option. Available actuators, see pages F-13 and F-14.
Terminal bend radii and lead-in manufacturing option.

AV2 (STD.) VERTICAL RIGHT ANGLE, PC THRU-HOLE, .150" PITCH



7101J1AV2BE2
Vertical Actuation
SPDT

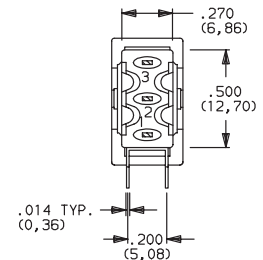
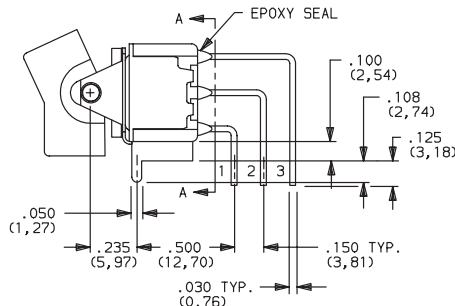
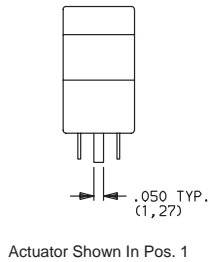

AV3 VERTICAL RIGHT ANGLE, SNAP-IN, PC THRU-HOLE, .150" PITCH



Rocker

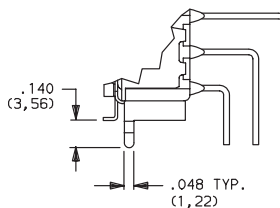
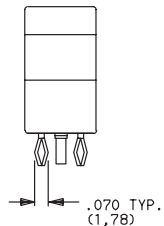

PC MOUNTING

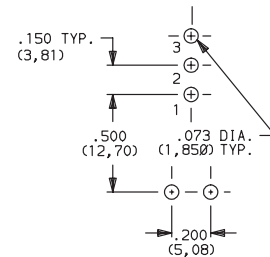

Not available with I seal option. Available actuators, see pages F-13 and F-14.
Terminal bend radii and lead-in manufacturing option.

C&K 7000 Series Rocker and Lever Handle Switches

TERMINATIONS

AV2 (STD.) VERTICAL RIGHT ANGLE, PC THRU-HOLE, .150" PITCH

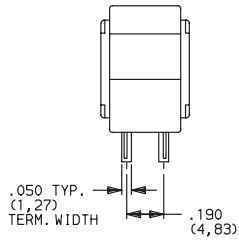

Actuator Shown In Pos. 1

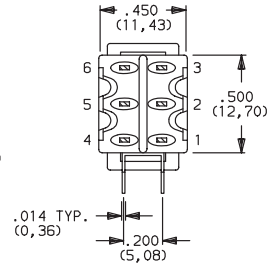
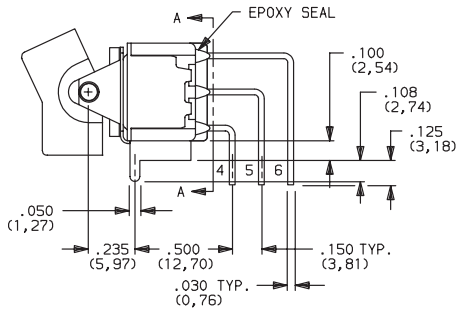

SECTION A-A

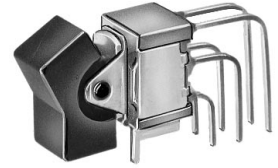

7201J1AV2BE2
Vertical Actuation
DPDT

AV3 VERTICAL RIGHT ANGLE, SNAP-IN, PC THRU-HOLE, .150" PITCH

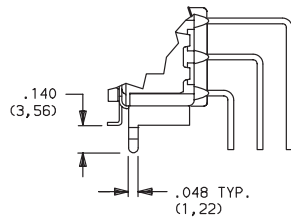
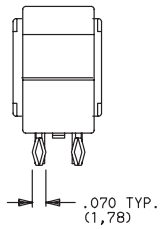

PC MOUNTING

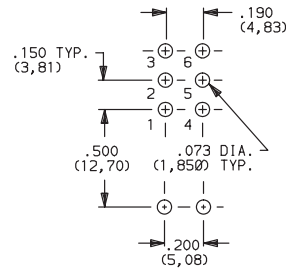

Not available with I seal option. Available actuators, see pages F-13 and F-14.
Terminal bend radii and lead-in manufacturing option.

AV2 (STD.) VERTICAL RIGHT ANGLE, PC THRU-HOLE, .150" PITCH

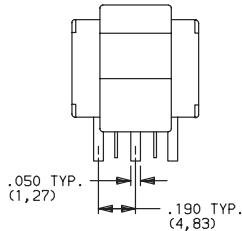

Actuator Shown In Pos. 1

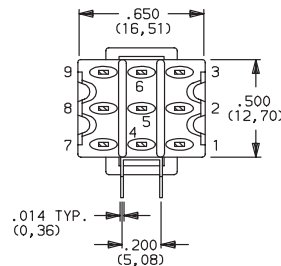
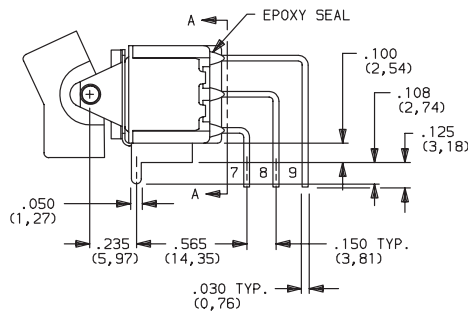

SECTION A-A

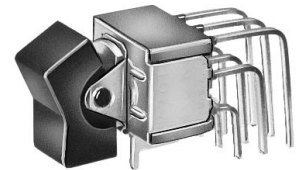

7301J1AV2BE2
Vertical Actuation
3PDT

AV3 VERTICAL RIGHT ANGLE, SNAP-IN, PC THRU-HOLE, .150" PITCH

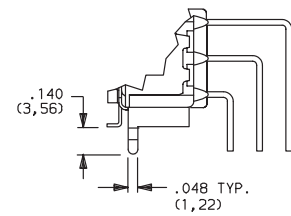
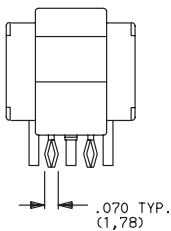

PC MOUNTING

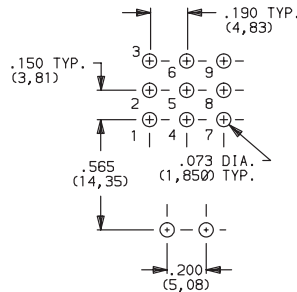

Not available with I seal option. Available actuators, see pages F-13 and F-14.
Terminal bend radii and lead-in manufacturing option.

C&K 7000 Series Rocker and Lever Handle Switches

TERMINATIONS

AV2 (STD.) VERTICAL RIGHT ANGLE, PC THRU-HOLE,
.150" PITCH

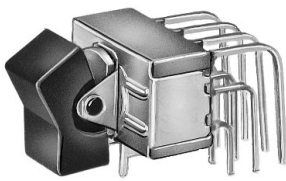

7401J1AV2BE2
Vertical Actuation
4PDT

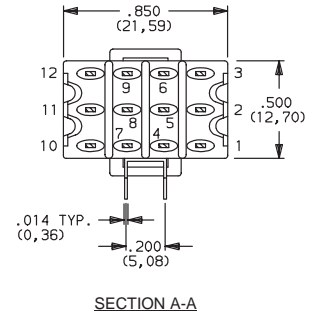
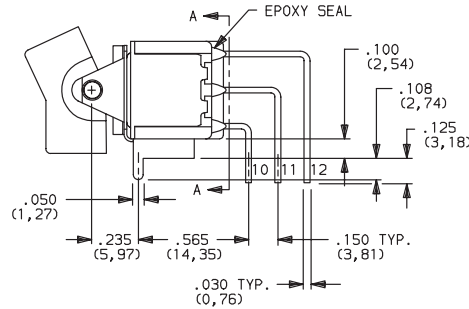
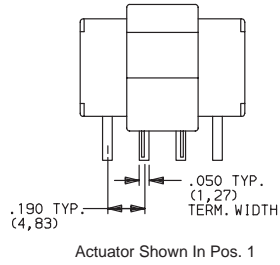

AV3 VERTICAL RIGHT ANGLE, SNAP-IN, PC THRU-HOLE,
.150" PITCH

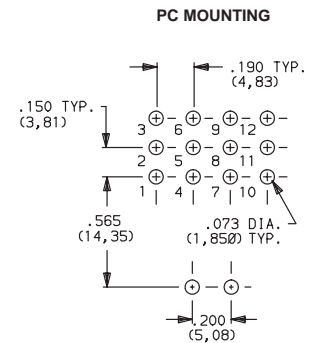
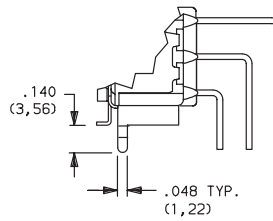
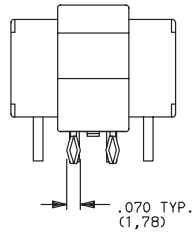

Not available with I seal option. Available actuators, see pages F-13 and F-14.
Terminal bend radii and lead-in manufacturing option.

V5 VERTICAL RIGHT ANGLE, PC THRU-HOLE,
.150" PITCH

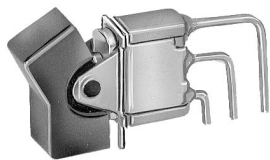

7101J1V5BE2
Vertical Actuation
SPDT

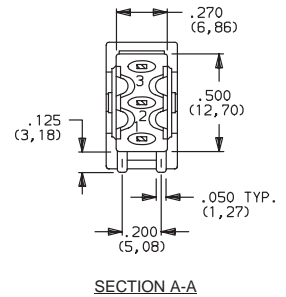
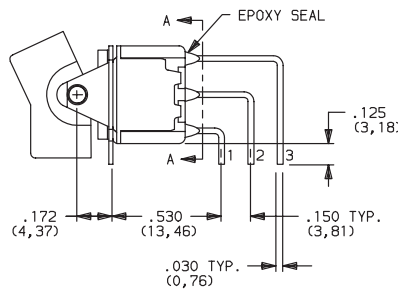
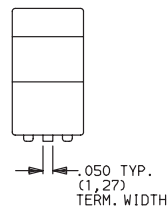

V51 VERTICAL RIGHT ANGLE, SNAP-IN,
PC THRU-HOLE, .150" PITCH

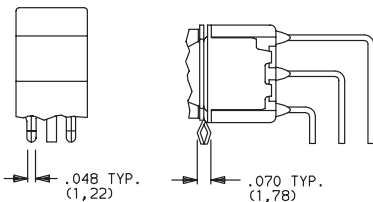

V54, V55 VERTICAL RIGHT ANGLE, EXTENDED,
PC THRU-HOLE, .150" PITCH

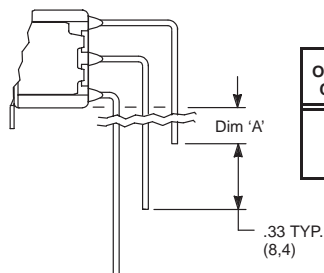

OPTION CODE	DIM 'A'
V54	.24 (6,1)
V55	.48 (12,2)

PC MOUNTING

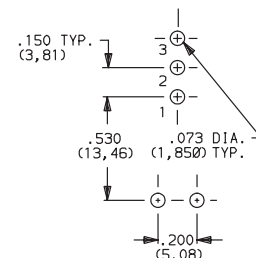

Not available with I seal option. Available actuators, see pages F-13 and F-14.
Terminal bend radii and lead-in manufacturing option.

C&K 7000 Series Rocker and Lever Handle Switches

TERMINATIONS

V5 VERTICAL RIGHT ANGLE, PC THRU-HOLE,
.150" PITCH

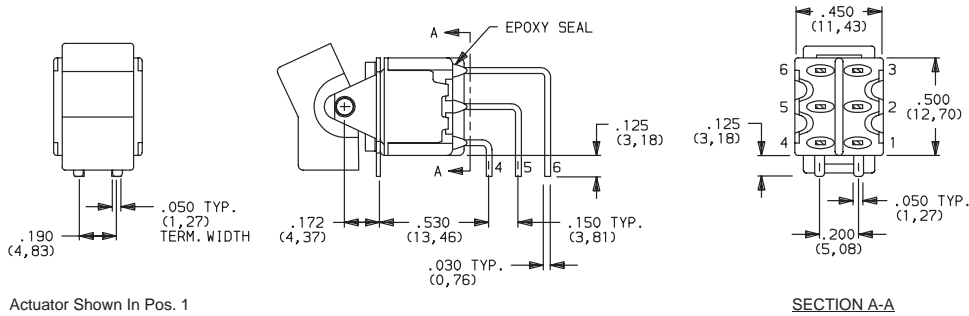

Actuator Shown In Pos. 1

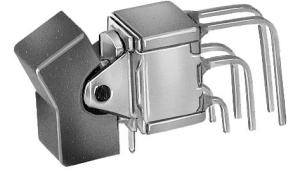

7201J1V5BE2
Vertical Actuation
DPDT

V51 VERTICAL RIGHT ANGLE, SNAP-IN,
PC THRU-HOLE, .150" PITCH

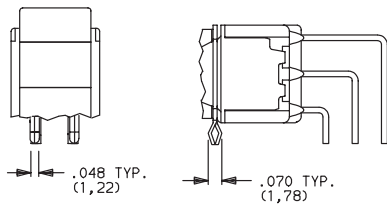

V54, V55 VERTICAL RIGHT ANGLE, EXTENDED,
PC THRU-HOLE, .150" PITCH

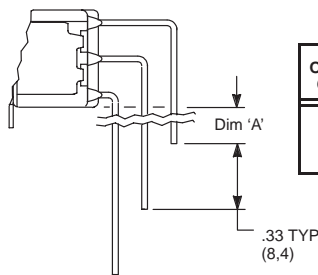

OPTION CODE	DIM 'A'
V54	.24 (6,1)
V55	.48 (12,2)

PC MOUNTING

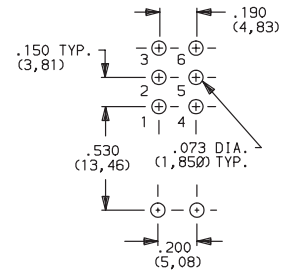

Not available with I seal option. Available actuators, see pages F-13 and F-14.
Terminal bend radii and lead-in manufacturing option.

V2, V6, V7, V8 VERTICAL MOUNT, V-BRACKET

V21, V61, V71, V81 VERTICAL MOUNT, V-BRACKET, SNAP-IN

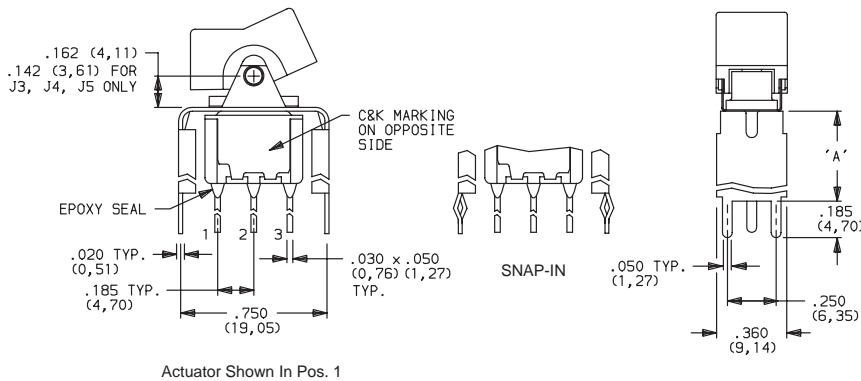

Actuator Shown In Pos. 1

PC MOUNTING

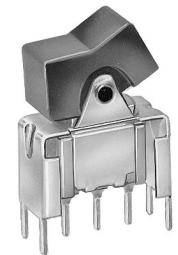
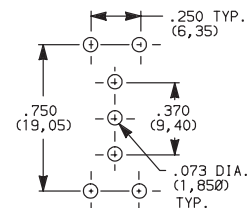

7101J1_BE2
SPDT

OPTION CODE	DIM 'A'
V2, V21	.555 (14,10)
V6, V61	.460 (11,68)
V7, V71	.630 (16,00)
V8, V81	.953 (24,21)

Not available with I seal option.
Available actuators, see pages F-13 and F-14.

C&K 7000 Series Rocker and Lever Handle Switches

TERMINATIONS

V4, V9 VERTICAL MOUNT, V-BRACKET

V41, V91 VERTICAL MOUNT, V-BRACKET, SNAP-IN

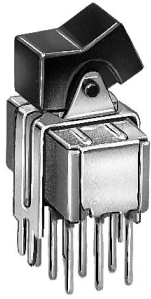

7401J1_BE2
4PDT

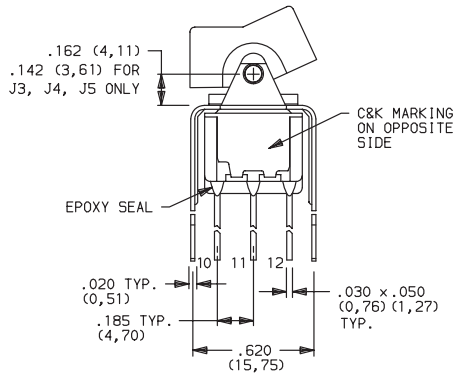

Actuator Shown In Pos. 1

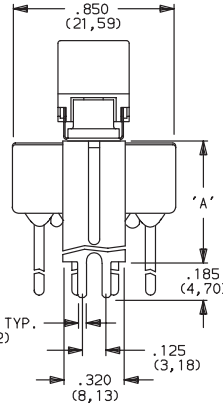

PC MOUNTING

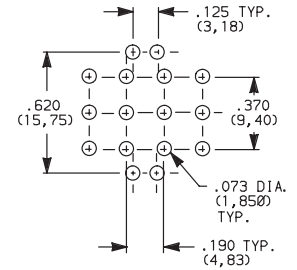

OPTION CODE	DIM 'A'
V4, V41	.630 (16,00)
V9, V91	1.150 (29,21)

Not available with I seal option.
Available actuators, see pages F-13 and F-14.

CONTACT MATERIAL

OPTION CODE	CONTACT MATERIAL	TERMINAL PLATING	RATINGS	
B (STD.)	GOLD ¹	GOLD ¹	LOW LEVEL/ DRY CIRCUIT	0.4 VA MAX. @ 20 V AC OR DC MAX.
K		TIN-LEAD ⁶		
Q (STD.)	SILVER ^{4,5}	SILVER ⁵	POWER	5 AMPS @ 120 V AC OR 28 V DC; 2 AMPS @ 250 V AC.
M		TIN-LEAD ⁶		
G	GOLD OVER SILVER ^{2,3}	GOLD ³	LOW LEVEL/ DRY CIRCUIT OR POWER	0.4 VA MAX. @ 20 V AC OR DC MAX. OR 5 AMPS @ 120 V AC OR 28 V DC; 2 AMPS @ 250 V AC.
L		TIN-LEAD ⁶		

CONTACT MATERIAL/APPLICATION RECOMMENDATIONS—SEE CHART, PAGE L-31.

- CONTACTS & TERMINALS: Copper alloy, with gold plate over nickel plate.
- END CONTACTS: Coin silver, with gold plate over nickel plate.
- CENTER CONTACTS & ALL TERMINALS: Copper alloy, with gold plate over nickel plate.
- END CONTACTS: Coin silver, silver plated.
- CENTER CONTACT & ALL TERMINALS: Copper alloy, silver plated.
- TERMINALS: Copper alloy, with tin-lead alloy over nickel plate.

U11-U415 model numbers with all options when ordered with G, L, M or Q contact material.

B contact material standard with all terminations except C, Z & Z3.

Q contact material standard with C, Z & Z3 terminations.

K, L & M contact materials not available with Z & Z3 terminations.

SEAL

E (STD.) EPOXY SEAL

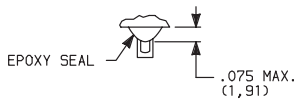

I EPOXY POTTED BASE

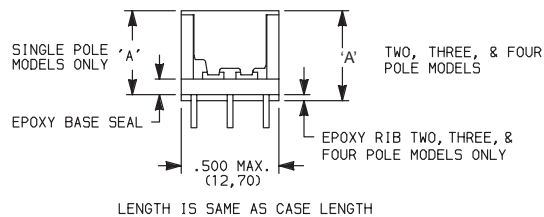

NO. POLES	DIM 'A'
SP	.410 (10,41)
DP	.440 (11,18)
3P	.505 (12,83)
4P	.505 (12,83)

Available with C, W-W5, Z & Z3 terminations.