

For technical assistance call the Sensors/
Controls Products number on the back cover.

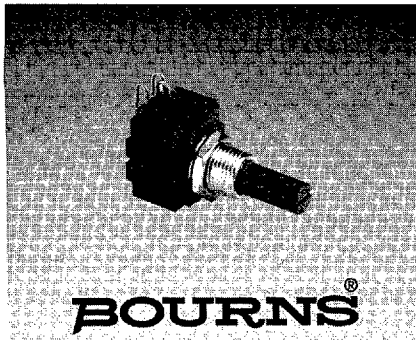

Features

- Features one-piece molded plastic
- Available in a variety of pin-out shaft and rotor assemblies configurations
- Virtually infinite electrical circuit
- Model 96 sealed for board wash
- Metal shaft available as special feature

91, 93, 95, 96 - 5/8" Square Single-Turn

Initial Electrical Characteristics*	Conductive Plastic Element	Cermet Element
Standard Resistance Range		
Linear Tapers (A, B, E, & H)	(B & E) 150 ohms to 1 megohms	(A & H) 50 ohms to 1 megohms
Audio Tapers (C, D, F, G S, & T)	(D, G, S, & T) 1K ohms to 5.0 megohms	(C & F) 1K ohms to 5.0 megohms
Resistance Tolerance	(B, D, & G tapers) ±20% (E, S, & T tapers) ±10%	(A, C, & F tapers) ±10% (H taper) ±5%
Independent Linearity	(B & E tapers) ±5%	(A & H tapers) ±5%
Absolute Minimum Resistance	2 ohms maximum	2 ohms maximum
Continuity	Maintained for full mechanical angle	Maintained for full mechanical angle
Effective Electrical Angle	240° ±5°	240° ±6°
Contact Resistance Variation	±1%	±1% or 3 ohms (whichever is greater)
Dielectric Withstanding Voltage	MIL-STD-202, Method 301	MIL-STD-202, Method 301
Sea Level	1,500 VAC minimum	1,500 VAC minimum
70,000 Feet	500 VAC minimum	500 VAC minimum
Insulation Resistance (500 VDC)	1,000 megohms minimum	1,000 megohms minimum
Power Rating (Voltage Limited By Power Dissipation or 350 VAC, Whichever Is Less)		
+70°C Single Section Assembly	(B & E tapers) 0.5 watt (D, G, S, & T tapers) 0.25 watt	(A & H tapers) 2 watts (C & F tapers) 1 watt
+70°C Multiple Section Assembly	(B & E tapers) 0.5 watt/section (D, G, S, & T tapers) 0.25 watt/section	(A & H tapers) 1 watt/section (C & F tapers) 0.5 watt/section
+125°C	0 watt	0 watt
Roll-on/Roll-off	(B & E tapers) 0.25% maximum (D & S tapers) 0.1% maximum CCW end (G & T tapers) 0.1% maximum CW end (D & S tapers) 0.5% maximum CW end (G & T tapers) 0.5% maximum CCW end	(A & H tapers) 0.5% maximum (C taper) 0.1% maximum CCW end (F taper) 0.1% maximum CW end (C taper) 1.0% maximum CW end (F taper) 1.0% maximum CCW end
Theoretical Resolution	Essentially infinite	Essentially infinite

Environmental Characteristics*	Conductive Plastic Element	Cermet Element
Operating Temperature	+1°C to +125°C	+1°C to +125°C
Storage Temperature Range	-55°C to +125°C	-55°C to +125°C
Temperature Coefficient		
Over Storage Temperature Range	±1,000PPM/°C	±150PPM/°C
Vibration (Single Section)	15G	15G
Total Resistance Shift	±2% maximum	±2% maximum
Voltage Ratio Shift	±5% maximum	±5% maximum
Shock (Single Section)	30G	30G
Total Resistance Shift	±2% maximum	±2% maximum
Voltage Ratio Shift	±5% maximum	±5% maximum
Load Life	1,000 hours	1,000 hours
Total Resistance Shift	±10% maximum	±5% maximum
Rotational Life (No Load)	100,000 cycles	100,000 cycles
Total Resistance Shift	(B & E tapers) 10 ohms or ±15% maximum (whichever is greater) (D, G, S, & T tapers) ±20% maximum	10 ohms or ±10% maximum (whichever is greater)
Contact Resistance Variation @ 50,000 cycles	(B & E tapers) ±2% (D, G, S, & T tapers) ±3%	
Moisture Resistance	MIL-STD-202, Method 103, Condition B	MIL-STD-202, Method 103, Condition B
Total Resistance Shift	(B & E tapers) ±10% maximum (D, G, S, & T tapers) ±20% maximum	(All tapers) ±5% maximum
Insulation Resistance (500 VDC)	100 megohms minimum	100 megohms minimum

Mechanical Characteristics*	Conductive Plastic Element	Cermet Element
Running Torque		
Single or Dual Section (A, D & r Bushings)	0.3 to 1.5 oz.-in. (0.21 to 1.06 Ncm)	0.3 to 1.5 oz.-in. (0.21 to 1.06 Ncm)
Single or Dual Section (C & U Bushings)	0.2 to 1.5 oz.-in. (0.14 to 1.06 Ncm)	0.2 to 1.5 oz.-in. (0.14 to 1.06 Ncm)
Starting Torque	0.3 maximum above average running torque	0.3 maximum above average running torque
Torque Variation	0.5 oz.-in. (0.35 Ncm) max. in 45° shaft travel	0.5 oz.-in. (0.35 Ncm) max. in 45° shaft travel
Stop Strength (1/4" D shaft)	4 in.-lb. (45.19 Ncm)	4 in.-lb. (45.19 Ncm)
(1/8" D shaft)	3 in.-lb. (33.89 Ncm)	3 in.-lb. (33.89 Ncm)
Mechanical Angle	300° ±5°	300° ±5°
Weight (Single Section)	7 grams maximum	7 grams maximum
Each Additional Section	4 grams maximum	4 grams maximum
Terminals	Printed circuit terminals, J-Hooks or solder lugs	Printed circuit terminals, J-Hooks or solder lugs
Marking	Manufacturer's trademark, date code, resistance, manufacturer's part number	Manufacturer's trademark, date code, resistance, manufacturer's part number

FOR DIMENSIONAL DRAWINGS SEE PAGE 208.

FOR ORDERING INFORMATION SEE PAGE 209.

NOTE: ALL MODEL 90 PERFORMANCE SPECIFICATIONS DO NOT APPLY TO UNITS SUBJECTED TO PRINTED CIRCUIT BOARD CLEANING PROCEDURES, EXCEPT FOR THE SEALED VERSION (MODEL 96).

*AT ROOM AMBIENT: +25°C NOMINAL AND 50% RELATIVE HUMIDITY NOMINAL, EXCEPT AS NOTED.

Specifications are subject to change without notice.

D 21F 1556573 0002096 69T

91, 93, 95, 96 Dimensions and Tolerances



Model 91 PC Pin Terminals, In-Line

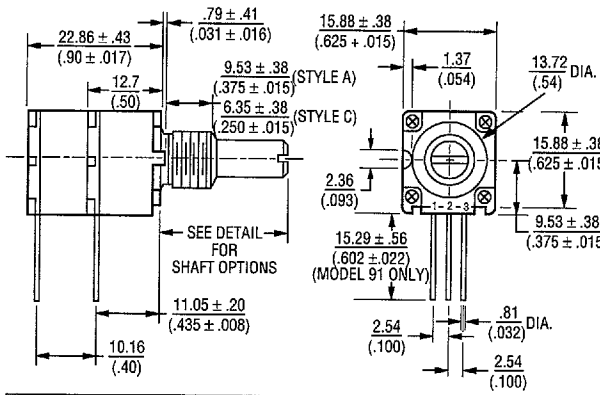

Model 95 Solder Lug Terminals, "Triangular" Pattern

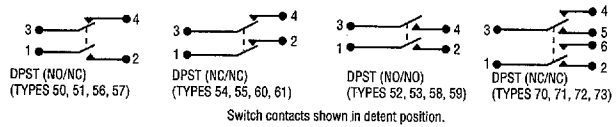
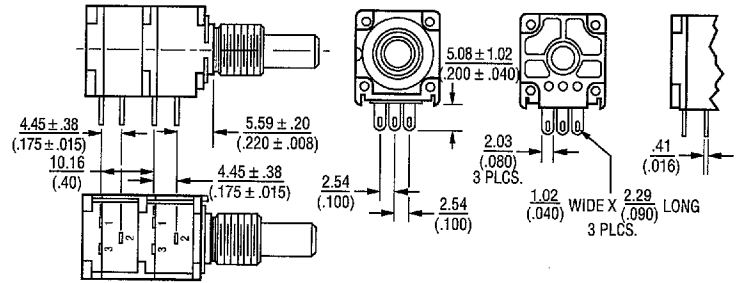

Model 93 PC Pin Terminals, "L" Pattern

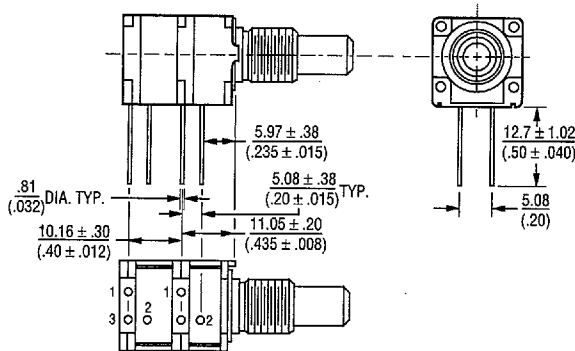

Bushing Styles

- 3/8 THREADLESS (9.53mm) (STYLE "D")
- 3/8-32 UNEF (9.53mm) (STYLE "A")
- 1/4-32 UNEF (6.35mm) (STYLE "C")
- M10 X 0.75-6g (STYLE "R")
- M7 X 0.75-6g (STYLE "U")

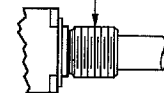

Shaft Styles

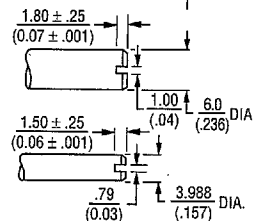
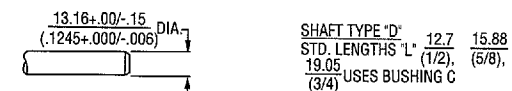
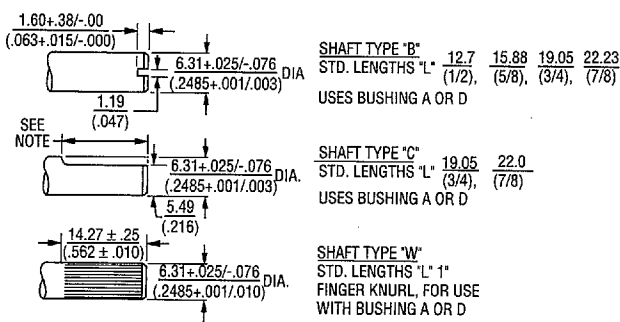

NOTE: FOR 19.05 SHAFT - FLAT LENGTH IS 7.95 (.313)
FOR 22.23 SHAFT - FLAT LENGTH IS 11.18 (.440)

TOLERANCES EXCEPT AS SHOWN: DECIMAL .XXX ± $\frac{.128}{.015}$, FRACTION ± 1/64
XX ± $\frac{.005}{.38}$ ANGLE ± 5°

DIMENSIONS ARE: METRIC
(INCHES)

90 Series Panel Controls Dimensions and Tolerances **BOURNS®**

How To Order

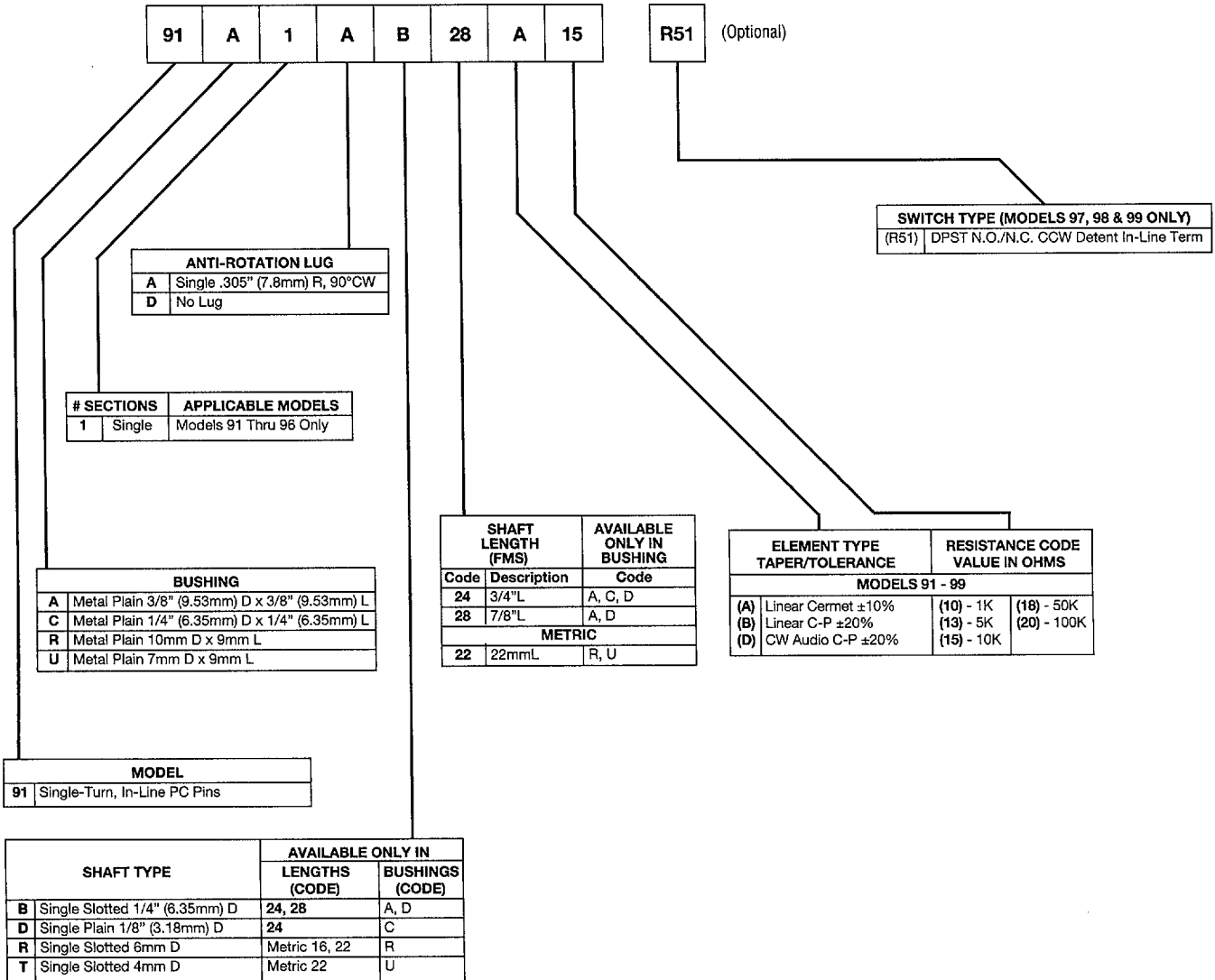

Recommended part numbers.
For other options contact the factory.
Boldface listings are in stock and readily available through distribution.