

If you have not found what you are looking for or you have further questions, please feel free to call us at 217-753-7797 or fax us at 217-753-7789. It will help us process your request more efficiently and effectively if you can provide as much detailed information about your requirements/application as possible.

Thanks for considering Hobbs meters from Honeywell!

MANUFACTURING

Honeywell Hobbs' commitment to the customer in past years and present is what has helped us develop our world-class manufacturing systems. Some of the methods by which we continuously improve our products and processes are as follows:

- Six Sigma methodology is a strategy used to accelerate improvements in our processes, products and services, and to reduce manufacturing costs and improve quality. It achieves this by relentlessly focusing on eliminating waste and reducing defects and variations.
- Continuous Flow Process utilizing "Rabbit Chase" concepts are used in the focused factories in order to achieve the lowest total cost, defect-free product.
- Single Minute Exchange of Dies (SMED method) provides reduced time in molding cell.
- Statistical Process Control is used for measuring critical dimensions and controlling manufacturing processes.
- Poka-Yoke method and computerized test equipment are utilized to eliminate scrap and rework.
- Kanban cards are used to pull raw material and piece parts through the factory.
- Bar coding and electronic data interchange (EDI) are available.

QUALITY SYSTEMS

It is the goal of Honeywell Hobbs to meet customer value-needs through continuously improved products and processes. That is the basis by which we work to create a partnership with our customers. Evidence of our commitment is proven by a goal of a Shipped Product Quality Level (SPQL) of 100 ppm. We utilize Advanced Quality Planning and QS9000 based quality systems.

© 2003 Honeywell International Inc. All Rights Reserved.



Sensing and Control

HOBBS:

HOUR METERS



Honeywell

Sensing and Control
www.honeywell.com/hobbs
 email: www.honeywellhobbs.marketing@honeywell.com
 Honeywell
 P.O. Box 19424
 Springfield, IL 62794-9424
 USA

Catalog 20-1103, GLO Printed in the USA



The Hobbs brand is well known worldwide for the development of quality electro-mechanical products. The invention of the first electrically wound automobile clock in 1938 created what is now known as Honeywell Hobbs. John Weston Hobbs was the inventor that cultivated this electrically-wound vehicle clock into a company that has over the years expanded to include hour meters, pressure and vacuum switches, halogen lamps, transmission shifters, and other custom electro-mechanical products. Honeywells' broad customer and market base includes industries such as automotive, agricultural, material handling, construction, marine, medical, heavy truck, lawn and garden, recreational, generators, compressors and aviation. Honeywells' commitment to continuous improvement and total quality management will allow for further expansion of its product lines and customer base while maintaining the highest standards of excellence.



Contents:	
• LCD.....	P. 3-5
• D.C.....	P. 6-7
• A.C.....	P. 8-11
• Accessories	P. 11
• Warranty	P. 11

www.honeywell.com/hobbs

Other AC and DC Meters Available

Round Flush with Retainer Mount

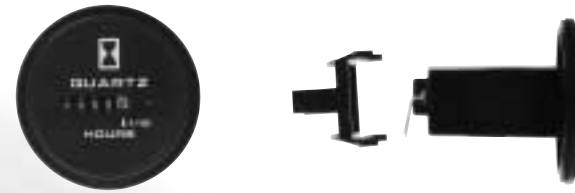

Round Slotted 3 screw



Contact Hobbs for more information and specifications on above meters.

Hour Meter Accessories

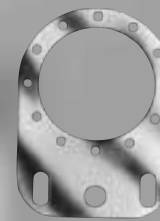

Mounting brackets. For mounting hour meters in any location when panel installation is not practical. Multiple holes allow positioning for easy reading. Foot of bracket can be bent when necessary. Part Number M-329 (2 13/16" x 4") for meter only. Part Number M-558 (4" x 5 1/8") when meter and damper are used together.

Damper. Protects meter from severe vibration. Use on panel or with Part Number M-558 bracket. Part Number M-3888 (3 7/8" dia.) for three-screw type DC meters.

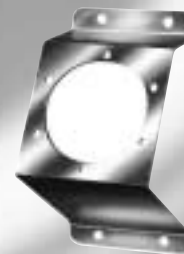
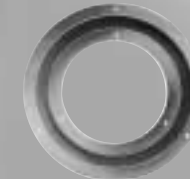

Panel mounting bracket. Designed to bolt to a flat surface area 2 13/16" x 5 1/4". Provides easy-to-read meter position. Part Number M-486 for three-screw type DC meter only.

Angle bracket. For two-screw flange AC and DC rectangular meters only, when panel mounting is not practical. Part Number 23944.

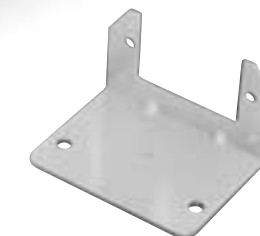

Custom Instrument Panel Clusters

Let Hobbs custom design your display panel saving you time and money. We can assemble a panel to your specifications that frees up your engineering resources, reduces parts counts and reduces your vendor base.



Warranty and remedy

Honeywell warrants goods of its manufacture as being free of defective materials and faulty workmanship. Contact your local sales office for warranty information. If warranted goods are returned to Honeywell during the period of coverage, Honeywell will repair or replace without charge those items it finds defective. The foregoing is Buyer's sole remedy and is in lieu of all other warranties, expressed or implied, including those of merchantability and fitness for a particular purpose.

While we provide application assistance, personally, through our literature and the Honeywell web site, it is up to the customer to determine the suitability of the product in the application.

Specifications may change at any time without notice. The information we supply is believed to be accurate and reliable as of this printing. However, we assume no responsibility for its use.

Sales and Service

Honeywell serves its customers through a worldwide network of sales offices and distributors. For application assistance, current specifications, pricing or name of the nearest Authorized Distributor, contact a nearby sales office or

INTERNET: www.honeywell.com/hobbs

E-mail: honeywellhobbs.marketing@honeywell.com

Warranty Periods:

The products listed are warranted for the periods shown:

98000 Series.....2 years
 85000 Series.....2 years
 20000 Series.....2 years

28100 Series

Unlike conventional AC hour meters that are limited to one primary voltage and frequency, the Hobbs Multi-Range Quartz hour meter will operate over a full range of voltages and frequencies. The meters will work accurately over a voltage range of 90 VAC to 264 VAC and at frequencies of either 50 Hz or 60 Hz. This unique feature means that one hour meter will work for virtually any application anywhere in the world!

Specifications

- Operating Voltage: 90 to 264 VAC
- Frequencies: 50 to 60 Hz
- Temperature Range: -40°F to +185°F

Features

- Records time 0 to 99,999.9 hours
- Accuracy ±0.02%
- UL Recognized
- CSA (UL)
- CE Mark
- Totally sealed from dirt and moisture
- Termination - 1/4" spade

Benefits

- Reduced parts count
- Reduced inventories
- Fewer purchase orders
- Eliminate production line errors
- Reduce service parts

Options

- Wire leads
- Custom lens
- Terminals (up, down, straight)

WARNING!

Applied voltage not to exceed 264 Vac RMS. This meter was not intended to be used in applications where excessive transient voltages are present. It is the responsibility of the customer to determine the suitability of this device for use in their system.

* Panel cutout dimensions are ± .010 tolerance
All dimensions shown in inches and (metric)

AC Multi-Range Meters



Retainer Mount

Operating Voltage	Part #
90-264 VAC	28100

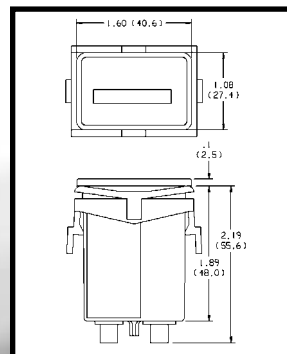

Retainer Mount:
Panel cutout 1.45 x .95 rectangular opening.
Two .150 holes spaced 1.750*



2 Screw Standard Bezel

Operating Voltage	Part #
90 to 264 VAC	28101

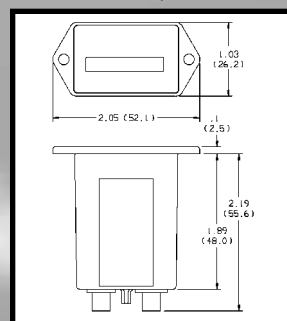

2 Screw Standard:
Panel cutout 1.45 x .95 rectangular opening.
Two .150 holes spaced 1.750*



2 Screw Deluxe Bezel

Operating Voltage	Part #
90 - 264 VAC	28103

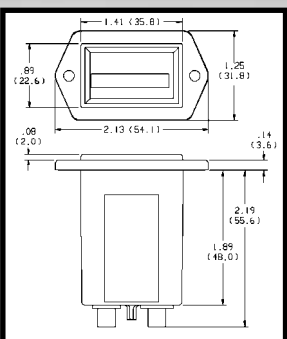

2 Screw Deluxe:
Panel cutout 1.45 x .95 rectangular opening.
Two .150 holes spaced 1.750*

98000 Series

The Hobbs 98000 Series LCD hour meters provide a large easy-to-read display in a conventional size package. The hour meters are available in a variety of mounting styles and voltage ranges that will fit virtually any application.

Specifications:

- Run Accuracy ±200ppm; ±0.02%
- Start Time: maximum 1second
- 6 Digit Display
- Digit Height: 6mm
- Power draw: .8 mA at 12 VDC (Power Terminal)
- Termination: 1/4" blade 3/16" blade optional
- Temperature Range: Operating: -40°C to +85°C
- Vibration: 20 g's per SAE J1378
- Shock: 55 g's per SAE J1378
- Operating ranges: 4.5 to 16 VDC (optional) 9 to 64 VDC >64 VDC Contact Factory
- Display: 0 to 99,999.9 Hours 0 to 999,999 Counter
- Transient Voltage Protection Load Dump Inductive EMI Reverse Polarity

Features

- Totally sealed from moisture and dirt
- Direct replacement for current hour meter
- No battery backup needed
- Fits in existing panel openings
- Custom bezels and dial artwork available
- Snap-in retainer mount combines easy installation with rugged design
- Compact Depth
- Rugged Design
- Pulse Counter Option
- Reset Option
- Run Indicator

* Panel cutout dimensions are ± .010 tolerance
All dimensions shown in inches and (metric)

LCD Hour Meters

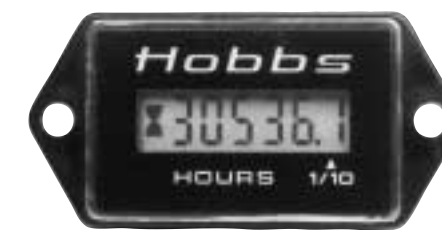

2 Screw Standard Bezel

Operating Voltage	Terminals	Part #
9 to 64 VDC	2 terminal	98310
9 to 64 VDC	3 terminal with enable	98320
9 to 64 VDC	4 terminal resettable	98300

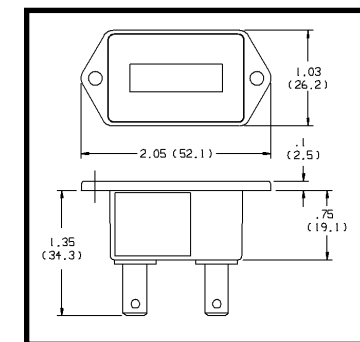

2 Screw Standard:
Panel cutout 1.45 x .95 rectangular opening
Two .150 holes spaced 1.750*



2 Screw Deluxe Bezel

Operating Voltage	Terminals	Part #
9 to 64 VDC	2 terminal	98313
9 to 64 VDC	3 terminal with enable	98323
9 to 64 VDC	4 terminal resettable	98303

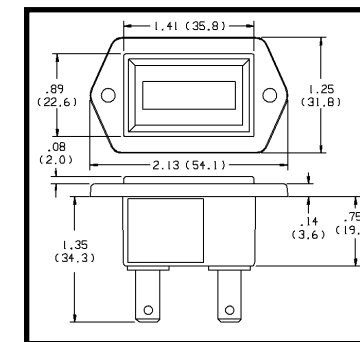

2 Screw Deluxe:
Panel cutout 1.45 x .95 rectangular opening
Two .150 holes spaced 1.750*



Round Black Bezel

Operating Voltage	Part #
90 - 264 VAC	28104

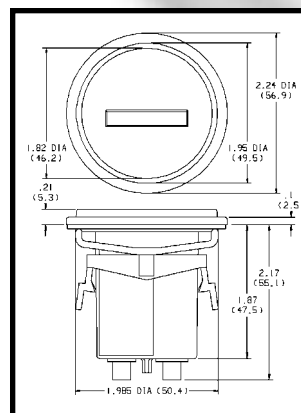

Flush Mount (Retainer) 2.24":
Panel cutout 2.00 diameter opening*



3 Screw

Operating Voltage	Part #
90 - 264 VAC	28105

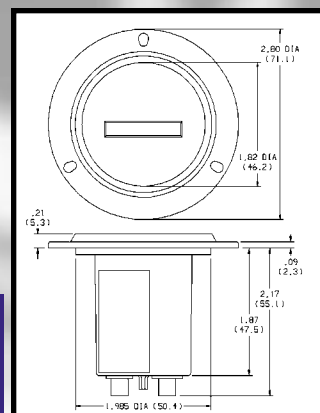

3 Screw Mount:
Panel cutout 2.00 diameter opening
Three .125 holes equally spaced on 2.42 bolt circle diameter*

LCD Meter APPLICATIONS

- Garden Tractors
- Generators
- Utility Vehicles
- Construction Equipment
- Material Handling Equipment
- Recreational Vehicles
- Medical
- Electronic Panels
- Rental Equipment
- Boom Lifts
- Pressure Washers
- Sweepers
- Test Equipment



Retainer Mount

Operating Voltage	Terminals	Part #
9 to 64 VDC	2 terminal	98311
9 to 64 VDC	3 terminal with enable	98321
9 to 64 VDC	4 terminal resettable	98301

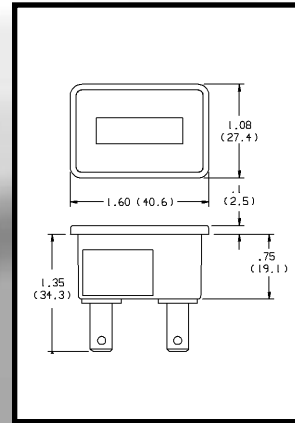

Retainer Mount: Panel cutout 1.45 x .95 rectangular opening*



Round Chrome Bezel

Operating Voltage	Terminals	Part #
9 to 64 VDC	2 terminal	98314
9 to 64 VDC	3 terminal with enable	98324
9 to 64 VDC	4 terminal resettable	98304

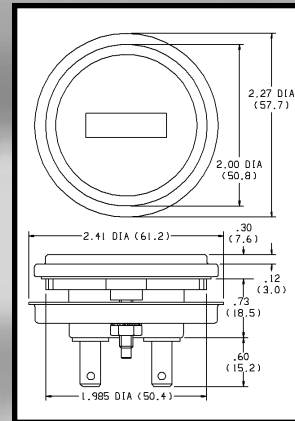

Flush Mount (Retainer) 2.27": Panel cutout 2.00 diameter opening*



Round Black Bezel

Operating Voltage	Terminals	Part #
9 to 64 VDC	2 terminal	98312
9 to 64 VDC	3 terminal with enable	98322
9 to 64 VDC	4 terminal resettable	98302

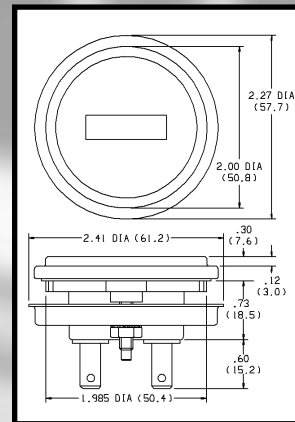

Flush Mount (Retainer) 2.27": Panel cutout 2.00 diameter opening*



Rectangular Retainer Mount

Operating Voltage	Hertz	Termination	Part #
108-132 VAC	50	Screw*	20174
108-132 VAC	50	Blade**	20183
108-132 VAC	60	Screw*	20116
108-132 VAC	60	Blade**	20182
216-264 VAC	50	Screw*	20171
216-264 VAC	50	Blade**	20170
216-264 VAC	60	Screw*	20177

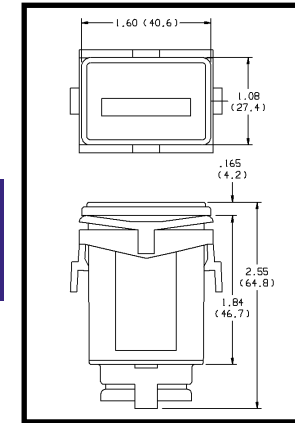

Rectangular Retainer: Panel cutout 1.45 x .95 rectangular opening*



Square Retainer Mount

Operating Voltage	Hertz	Termination	Part #
108-132 VAC	50	Screw*	20176
108-132 VAC	60	Screw*	20115
216-264 VAC	50	Screw*	20173
216-264 VAC	60	Screw*	20179

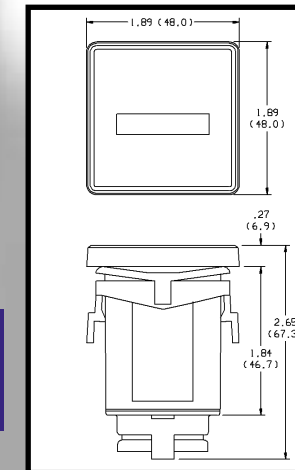

Square Retainer: Panel cutout 1.45 x .95 rectangular opening*

* UL Listed, CSA Certified and CE Mark
** UL Recognized, CSA Certified and CE Mark

* Panel cutout dimensions are ± .010 tolerance
All dimensions shown in inches and (metric)

CAUTION: Always make sure power is removed from equipment before working on electrical circuits! Only qualified personnel should make electrical connections. Damage to equipment and/or serious bodily injury can result from improperly made electrical connections, or a failure to adhere to normal electrical safety guidelines.

20000 Series Wiring Diagrams

120VAC Meter Applications

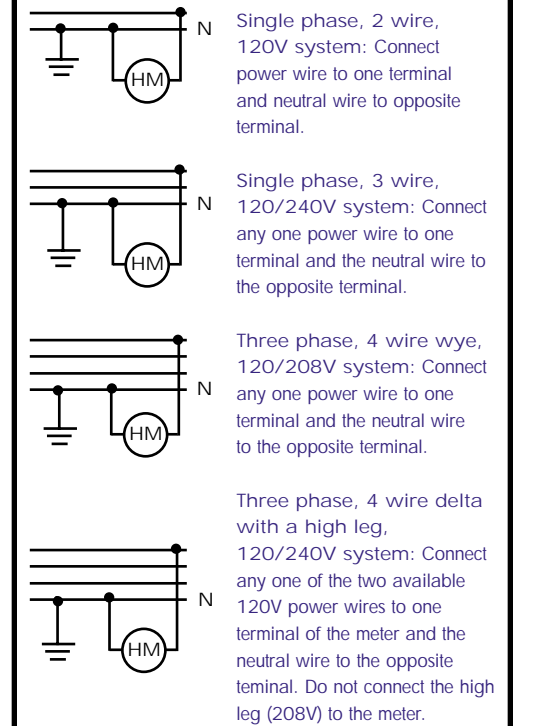

240VAC Meter Applications

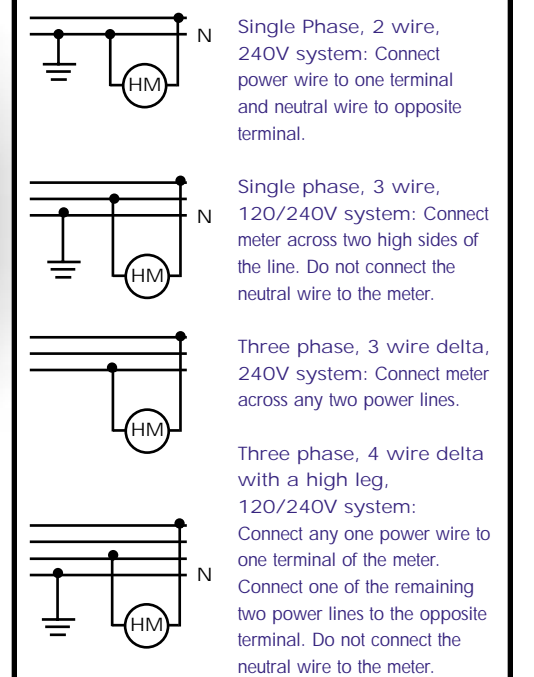

85000 Series

The 85000 Series provides legendary Hobbs performance and reliability in a technically advanced quartz package. The Quartz Plus features a highly reliable drive mechanism, an improved odometer gear train, and a snap-together integrated chassis. The chassis fits into a shockproof, totally-sealed case made of an engineered plastic that is impervious to acids and solvents.

To ensure our high standards of quality, all parts are in-process inspected. Every Quartz Plus meter must pass 100% function, burn-in, and timing accuracy test before shipping.

Specifications

- 10,000 hour version standard, with automatic recycle to zero
- Temperature range: -40° F to +185° F
-40° C to +85° C
- Quartz accuracy: ±200ppm, ±0.02% (entire voltage and temperature range)
- Operating voltage range: 5-110 VDC (Voltage range covered by 85000 Series line)
- Precision built relay driven odometer
- Excellent vibration & shock resistance:
Vibration: 20 g's @ 10-80Hz (SAE J1378)
10 g's (per MIL-M-3971)
Shock: 55 g's @ 9-13msec (SAE J1378)
75 g's (per MIL-M-3971)
- Transient Voltage Protection
Alternator load dump: 150V
EMI (Electromagnetic Interference): +400V @ 500Hz
Inductive switching and reverse polarity
- Standard terminals: 1/4" male blade
- Lens material: Glass
- Case material: Polyester
- Number size: 0.12" (3mm)

Features

- Custom CMOS integrated circuit
- Indicates operating time in hours and tenths, plus has a running indicator
- Totally-sealed
- Battery system voltages: 6,12,24,36,48,60,72,and 80 VDC
- UL Recognized (File number AU1774)
- CSA Certified (File number LR42455-12)
- Conforms to MIL-M-3971

Options:

Custom logos, polycarbonate lenses, and various bezels. Wire, stud, blade, and screw terminals. 100,000 hour, R-Terminal and filtered versions available too.

Quartz Plus DC Hour Meters



2 Screw

Operating Voltage	Part #
6.5-16 VDC	85331
10-32 VDC	85000
10-80 VDC	85094
30-110 VDC	85013

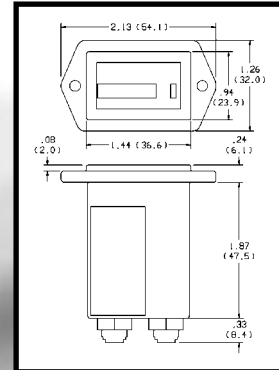

Two-Screw Mount: Panel cutout 1.45 x .95 rectangular opening. Two .150 holes spaced 1.750.*



3 Screw

Operating Voltage	Part #
10-32 VDC	85001
10-80 VDC	85097
30-110 VDC	85014

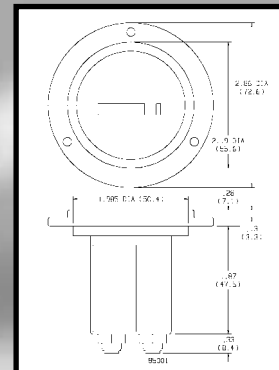

Three-Screw Mount: Panel cutout 2.00 diameter opening. Three .150 holes equally spaced on 2.53 bolt circle diameter.*



Rectangular Stirrup

Operating Voltage	Part #
10-32 VDC	85010
30-110 VDC	85023

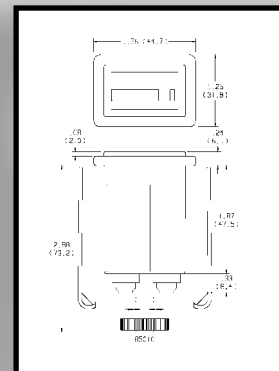

Rectangular Stirrup: Panel cutout 1.45 x .95 rectangular opening.*



Retainer Mount

Operating Voltage	Part #
10-32 VDC	82001
10-80 VDC	82320

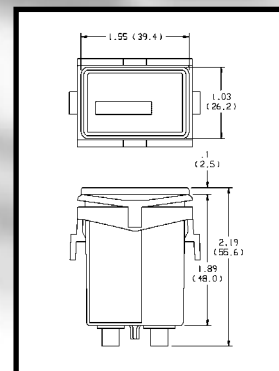

Retainer Mount: Panel cutout 1.45 x .95 rectangular opening.*

* Panel cutout dimensions are ± .010 tolerance
All dimensions shown in inches and (metric)

85000 Series Quartz Plus DC Hour Meters



Round Chrome Bezel

Operating Voltage	Part # Flush Cup 2.27"	Part # Flush Cup 2.50"	Part # Stirrup 2.27"	Part # Stirrup 2.50"
10-32 VDC	85002	85006	85004	85008
10-80 VDC	85342	85098		
30-110 VDC	85015	85019	85017	85021



Round Black Bezel

Operating Voltage	Part # Flush Cup 2.27"	Part # Flush Cup 2.50"	Part # Stirrup 2.27"	Part # Stirrup 2.50"
10-32 VDC	85003	85007	85005	85009
10-80 VDC	85093	85099		
30-110 VDC	85016	85020	85018	85022

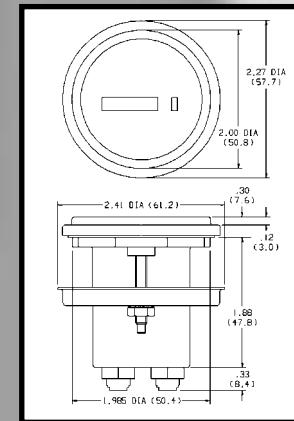

Flush Mount (Cup)
2.27": Panel cutout
2.00 diameter opening.*

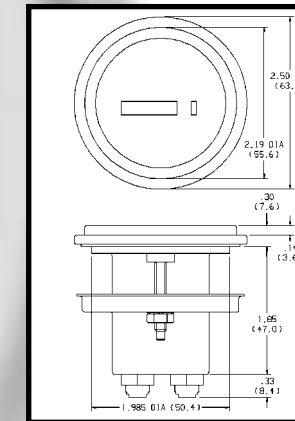

Flush Mount (Cup)
2.5": Panel cutout
2.00 diameter opening.*

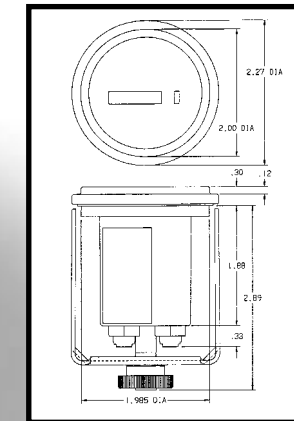

Flush Mount (Stirrup)
2.27": Panel cutout
2.00 diameter opening.*

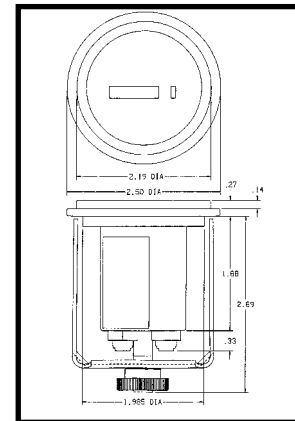

Flush Mount (Stirrup)
2.5": Panel cutout
2.00 diameter opening.*

* Panel cutout dimensions are ± .010 tolerance
All dimensions shown in inches and (metric)

85000 Series Wiring Diagrams (Polarity Sensitive)

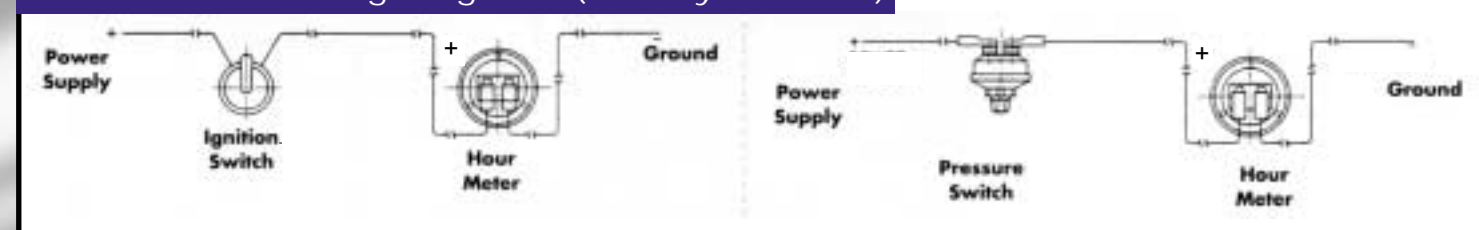

CAUTION: Always make sure power is removed from equipment before working on electrical circuits! Only qualified personnel should make electrical connections. Damage to equipment and/or serious bodily injury can result from improperly made electrical connections, or a failure to adhere to normal electrical safety guidelines

DC APPLICATIONS

- Lawn Tractors
- Garden Tractors
- Farm Equipment
- Gen Sets
- Construction Equipment
- Utility Vehicles
- Industrial Equipment
- Recreational Vehicles
- Golf Carts
- Aircraft
- Medical Equipment
- Office Equipment
- Any application requiring a very accurate and dependable hour meter.