

**SERIES: ACZ11**
**DESCRIPTION: mechanical incremental encoder**

## ELECTRICAL SPECIFICATIONS

parameter	conditions/description
output waveform	square wave
output signals	A, B phase
current consumption	10 mA
output phase difference	T1, T2, T3, T4 $\geq$ 3.5 ms @ 60 rpm (see output waveform)
supply voltage	5 V dc max.
output resolution	12, 15, 20, 30 ppr
switch rating	12 V dc, 50 mA (ACZ11BRXE models only)
insulation resistance	300 V dc, 100 M $\Omega$
withstand voltage	300 V ac

## MECHANICAL SPECIFICATIONS

parameter	conditions/description	min	nom	max	units
shaft load	axial			8	kgf
rotational torque	with detent click	60	140	220	gf · cm
	without detent click	60	80	100	gf · cm
push switch operational force	(ACZ11BRXE models only)	300		900	gf · cm
push switch life	(ACZ11BRXE models only)			50,000	cycles
rotational life				30,000	cycles

## ENVIRONMENTAL SPECIFICATIONS

parameter	conditions/description	min	nom	max	units
operating temperature		-10		65	$^{\circ}$ C
storage temperature		-40		75	$^{\circ}$ C
humidity		85			% RH
vibration	0.75 mm max. travel for 2 hours	10		55	Hz

## PART NUMBER KEY

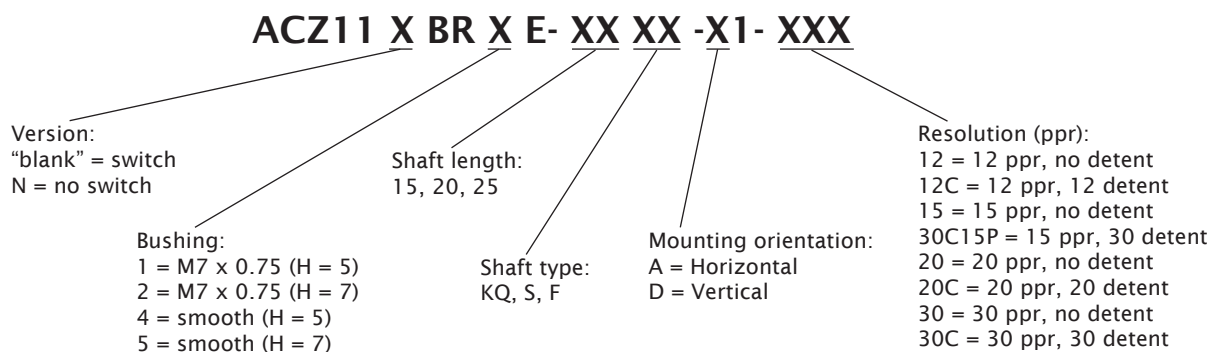

SERIES: ACZ11

DESCRIPTION: mechanical incremental encoder

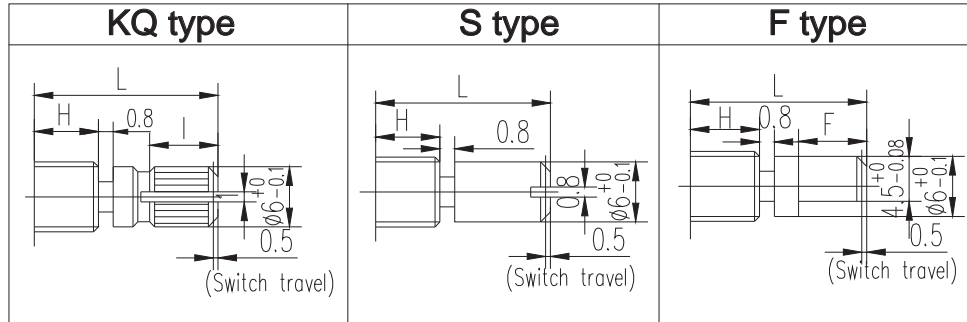
**SHAFT OPTIONS**

BUSHING		
Condition	H	
1	M7-P0.75	5
2	M7-P0.75	7
4	smooth	5
5	smooth	7

switch travel for ACZ11BRXE only

H=5			
	15KQ	20KQ	25KQ
L	15	20	25
I	7	10	12

H=7			
	15KQ	20KQ	25KQ
L	15	20	25
I	5	8.5	10

H=5			
	15S	20S	25S
L	15	20	25

H=7			
	15S	20S	25S
L	15	20	25

H=5			
	15F	20F	25F
L	15	20	25
F	8	12	12

H=7			
	15F	20F	25F
L	15	20	25
F	8	12	12

**OUTPUT WAVEFORM**

 CH A  
(Pins A & C)

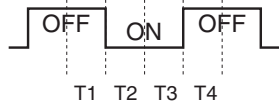
 CH B  
(Pins B & C)

CW direction (@ 60 rpm)

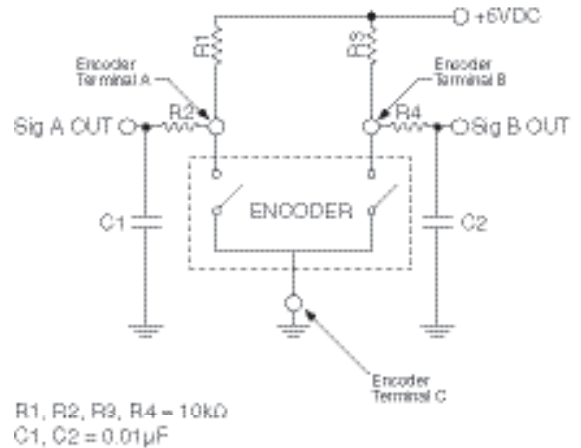
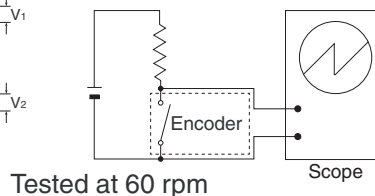
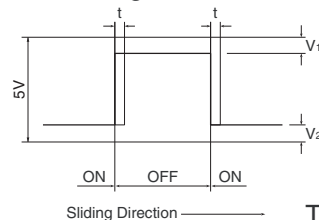
**SUGGESTED FILTER**

**SLIDING NOISE**
 $t$  = Masking time to avoid chatter (5mS)  $V_1 = V_2 = 1V$  max.

SERIES: ACZ11

DESCRIPTION: mechanical incremental encoder

**MECHANICAL DRAWING (horizontal)**

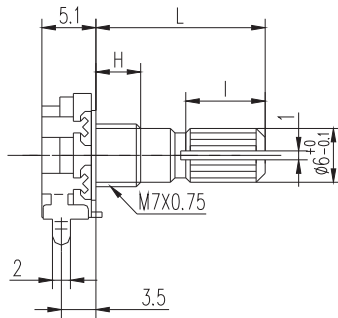
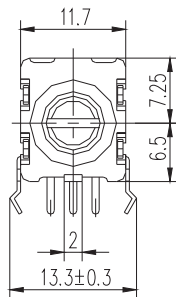
ACZ11NBRXE



PANEL CUT-OUT

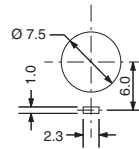

PCB LAYOUT

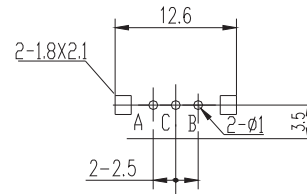

ACZ11BRXE

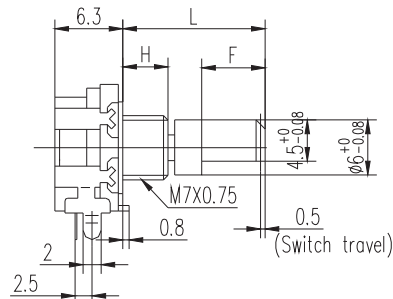
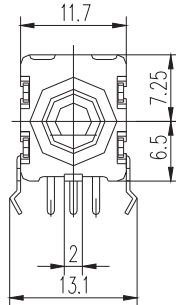

PANEL CUT-OUT

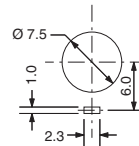

PCB LAYOUT

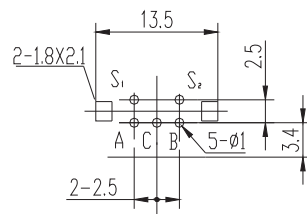
**MECHANICAL DRAWING (vertical)**

ACZ11NBRXE

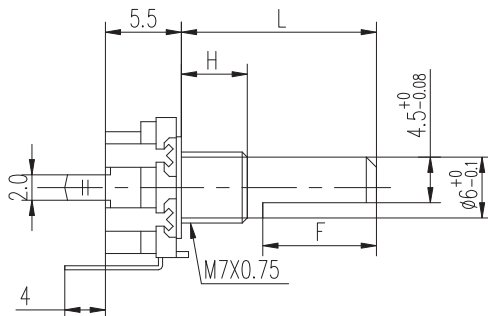
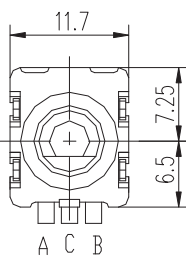

PANEL CUT-OUT

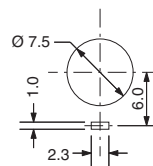

PCB LAYOUT

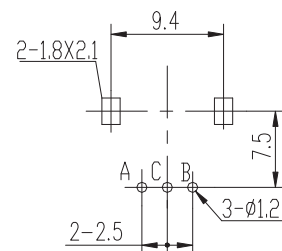

ACZ11BRXE

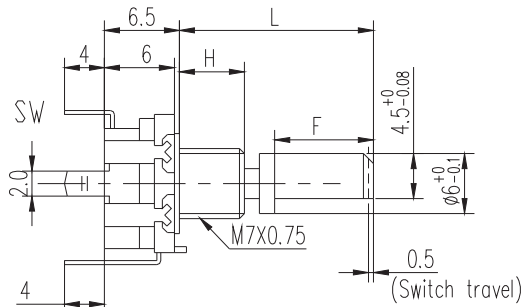
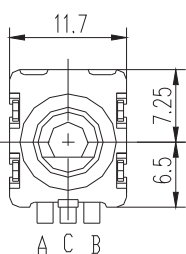

PANEL CUT-OUT

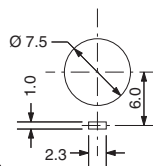

PCB LAYOUT

