

# ASMC-PxB9-Txxxx Envisium Power PLCC-4 Surface Mount LED Data Sheet

## Envisium

Envisium is the premier class of mid-Power LEDs from Agilent and Lumileds utilizing the very best solid-state lighting technologies from these two industry leaders. Envisium LEDs offer unparalleled performance, engineering and design flexibility. For the very first time, customers have options for mid-power LEDs.

## Description

The Envisium Power PLCC-4 SMT LED is an extension of Agilent's PLCC-4 SMT LEDs. The package can be driven at high current due to its superior package design. The product is able to dissipate the heat more efficiently compared to the conventional PLCC-2 SMT LEDs. These LEDs produce higher light output with better flux performance compared to the conventional PLCC-4 SMT LEDs.

The Envisium Power PLCC-4 SMT LEDs are designed for higher reliability, better performance, and operate under a wide range of environmental conditions. The performance characteristics of these new mid-power LEDs make them uniquely suitable for use in harsh conditions such as in automotive applications, and in electronics signs and signals.

To facilitate easy pick and place assembly, the LEDs are packed in EIA-compliant tape and reel. Every reel is shipped in single intensity and color bin (except for red), to provide close uniformity. These LEDs are compatible with the IR solder reflow process. Due to the high reliability feature of these products, they also can be mounted using through-the-wave soldering process.

The Envisium Power PLCC-4 SMT LED is available in 3 colors, red, red-orange and amber.

## Features

- Industry standard PLCC-4 (Plastic Leaded Chip Carrier)
- High reliability LED package
- Mid-Power intensity brightness with optimum flux performance using TS AlInGaP dice technologies
- Available in Red, Red Orange and Amber colors
- High optical efficiency
- Higher ambient temperature at the same current possible compared to PLCC-2
- Super wide viewing angle at 120°
- Available in 8 mm carrier tape on 7-inch reel
- Compatible with both IR and TTW soldering process

## Applications

- **Interior automotive**
  - Instrument panel backlighting
  - Central console backlighting
  - Navigation and audio system
  - Push button backlighting
- **Exterior automotive**
  - Turn signals
  - Side repeaters
  - CHMSL
  - Rear combination lamp
  - Puddle light
- **Electronic signs and signals**
  - Channel lettering
  - Contour lighting
  - Indoor variable message sign
- **Office automation, home appliances, industrial equipment**
  - Front panel backlighting
  - Push button backlighting
  - Display backlighting



## Package Dimensions

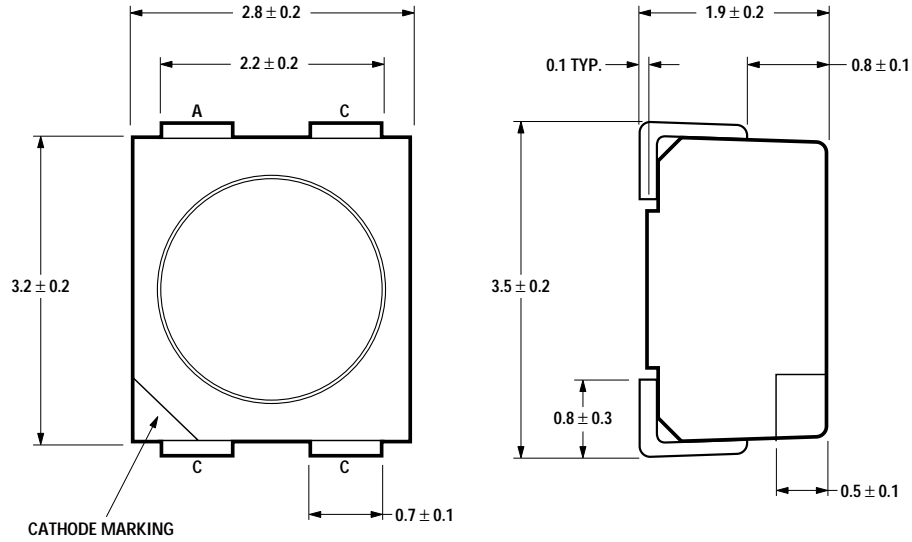

NOTE: ALL DIMENSIONS IN mm.

## Device Selection Guide

Color	Part Number	Intensity Bin	Min. $I_V$ (mcd)	Max. $I_V$ (mcd)	Total Flux $\Phi_V$ (lm) <sup>[2,3]</sup>	Test Current (mA)	Dice Technology
					Typ.		
Red	ASMC-PRB9-TV005	V1	630.00	1000.00	2600.00	50	AlInGaP
		V2	790.00	1260.00	3300.00		
		W1	1000.00	1600.00	-		
Red Orange	ASMC-PHB9-TW005	W1	1000.00	1600.00	4300.00	50	AlInGaP
		W2	1200.00	2020.00	5000.00		
		X1	1580.00	2500.00	-		
Amber	ASMC-PAB9-TV005	V1	630.00	1000.00	3000.00	50	AlInGaP
		V2	790.00	1260.00	3800.00		
		W1	1000.00	1600.00	-		

### Notes:

1. The luminous intensity,  $I_V$ , is measured at the mechanical axis of the lamp package. The actual peak of the spatial radiation pattern may not be aligned with this axis.
2.  $\Phi_V$  is the total luminous flux output as measured with an integrating sphere after the device has stabilized.
3. Flux tested at mono pulse conditions.

## Part Numbering System

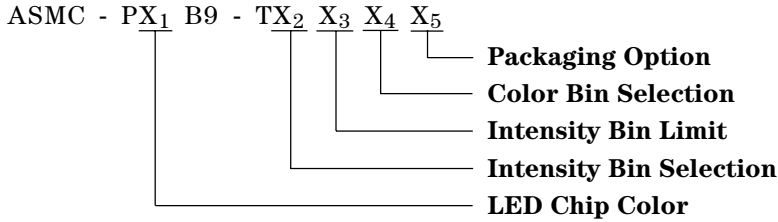

## Absolute Maximum Ratings (T<sub>A</sub> = 25°C)

Parameters	ASMC-PxB9-Txxxx
DC Forward Current <sup>[1]</sup>	70 mA <sup>[3,4]</sup>
Peak Forward Current <sup>[2]</sup>	200 mA
Power Dissipation	240 mW
Reverse Voltage	5 V
Junction Temperature	125°C
Operating Temperature	-40°C to +100°C
Storage Temperature	-40°C to +100°C

### Notes:

- Derate linearly as shown in figure 4.
- Duty factor = 10%, Frequency = 1 kHz.
- Drive current between 10 mA and 70 mA is recommended for best long-term performance.
- Operation at currents below 5 mA is not recommended.

## Optical Characteristics (T<sub>A</sub> = 25°C)

Color	Part Number	Dice Technology	Peak Wavelength	Dominant Wavelength	Viewing Angle 2θ <sup>1/2</sup> <sup>[2]</sup>	Luminous Efficacy η <sub>V</sub> <sup>[3]</sup>	Luminous Intensity/ Total Flux
			λ <sub>PEAK</sub> (nm)	λ <sub>D</sub> <sup>[1]</sup> (nm)	(Degrees)	(lm/W)	I <sub>V</sub> (mcd)/ Φ <sub>V</sub> <sup>[4,5]</sup> (lm)
			Typ.	Typ.	Typ.	Typ.	Typ.
Red	ASMC-PRB9-Txxx5	AlInGaP	639.0	630.0	120	155	0.30
Red Orange	ASMC-PHB9-Txxx5	AlInGaP	623.0	617.0	120	263	0.29
Amber	ASMC-PAB9-Txxx5	AlInGaP	594.0	592.0	120	500	0.26

### Notes:

- The dominant wavelength, λ<sub>D</sub>, is derived from the CIE Chromaticity Diagram and represents the color of the device.
- θ<sup>1/2</sup> is the off-axis angle where the luminous intensity is 1/2 the peak intensity.
- Radiant intensity, I<sub>e</sub> in watts/steradian, may be calculated from the equation I<sub>e</sub> = I<sub>V</sub>/η<sub>V</sub>, where I<sub>V</sub> is the luminous intensity in candelas and η<sub>V</sub> is the luminous efficacy in lumens/watt.
- Φ<sub>V</sub> is the total luminous flux output as measured with an integrating sphere after the device has stabilized.
- Flux tested at mono pulse conditions.

## Electrical Characteristics (T<sub>A</sub> = 25°C)

Part Number	Forward Voltage V <sub>F</sub> (Volts) @ I <sub>F</sub> = 50 mA		Reverse Voltage V <sub>R</sub> @ 100 μA
	Typ.	Max.	Min.
ASMC-PxB9-Txxx5	2.8	3.4	5

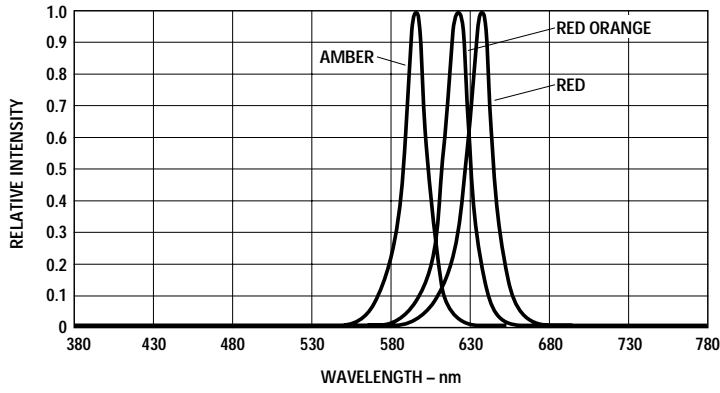

Figure 1. Relative intensity vs. wavelength.

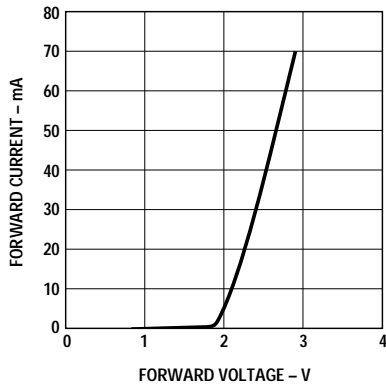

Figure 2. Forward current vs. forward voltage.

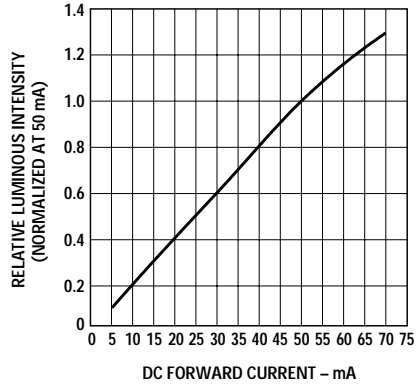

Figure 3. Relative intensity vs. forward current.

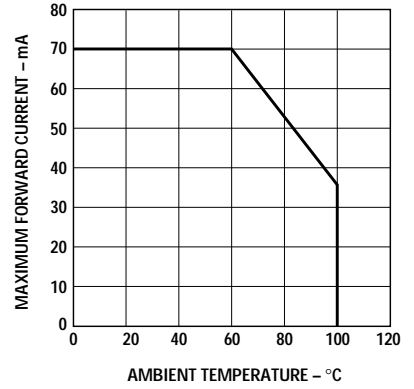

Figure 4. Maximum forward current vs. ambient temperature. Derated based on  $T_{jMAX} = 125^{\circ}C$ ,  $R_{\theta JA} = 300^{\circ}C/W$ .

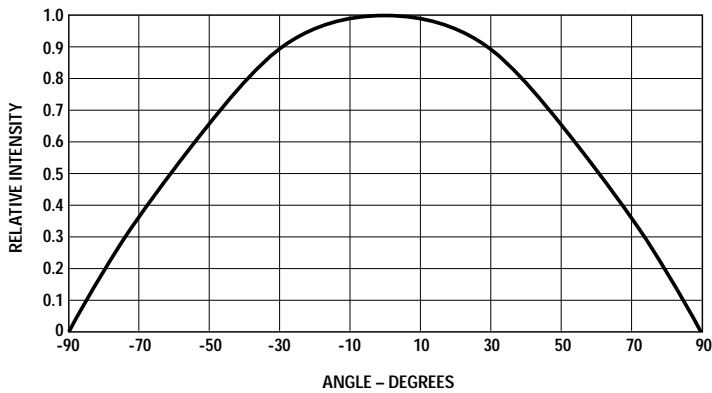

Figure 5. Radiation pattern.

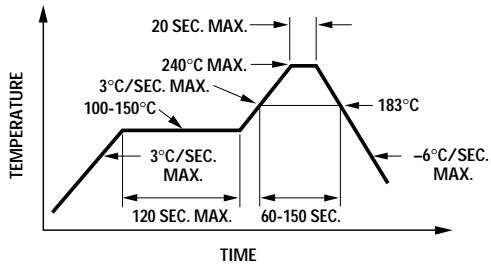
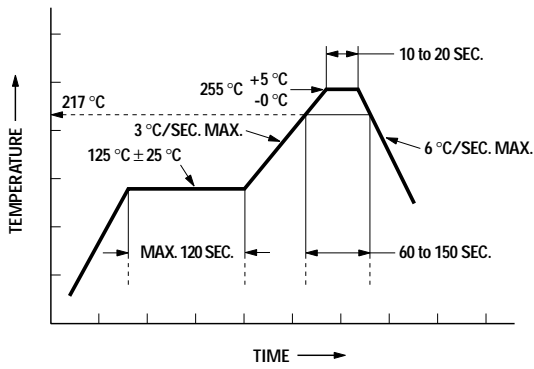

Figure 6a. Recommended Sn-Pb reflow soldering profile.



\* THE TIME FROM 25 °C TO PEAK TEMPERATURE = 6 MINUTES MAX.

Figure 6b. Recommended Pb-free reflow soldering profile.

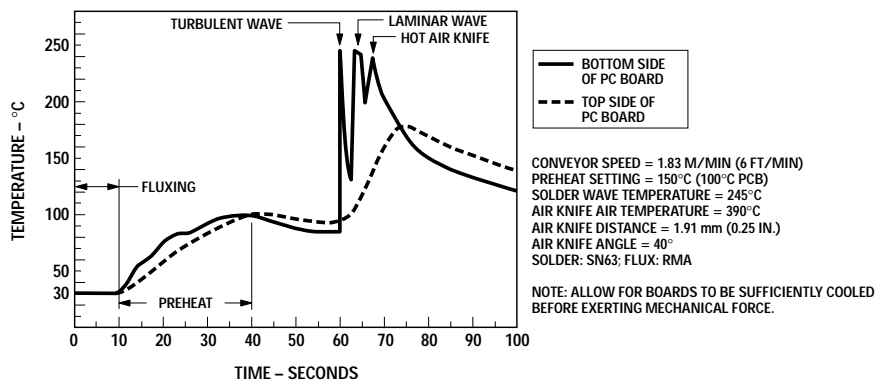

Figure 7. Recommended wave soldering profile.

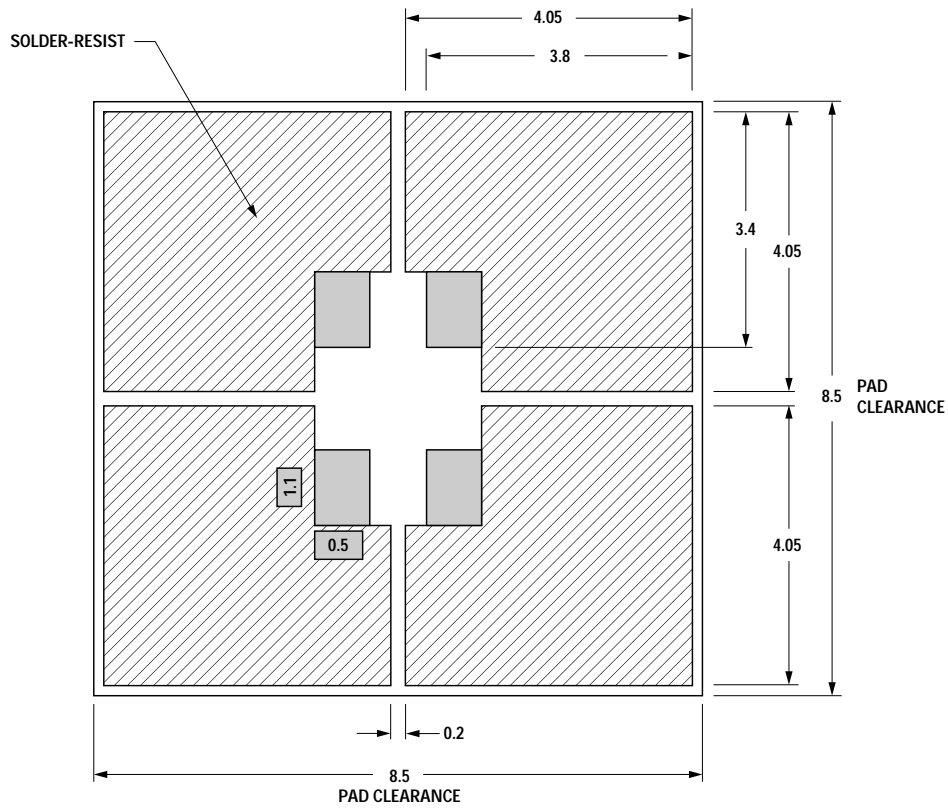

Figure 8. Recommended soldering pad pattern.

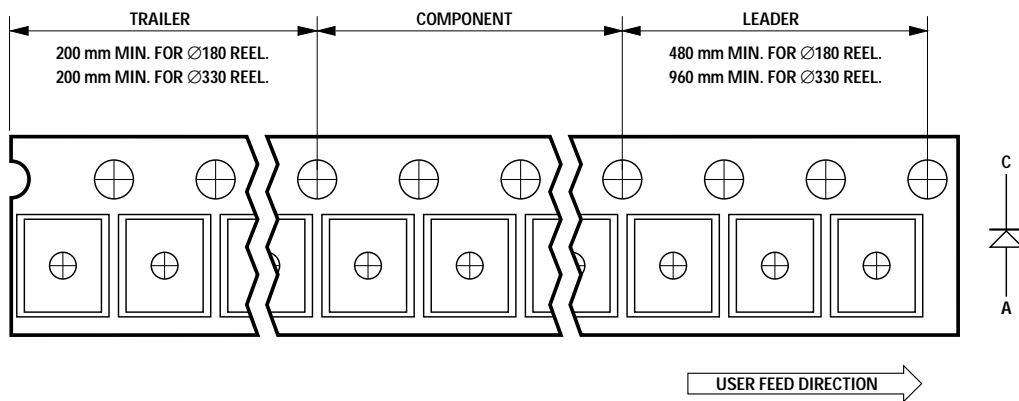

Figure 9. Tape leader and trailer dimensions.

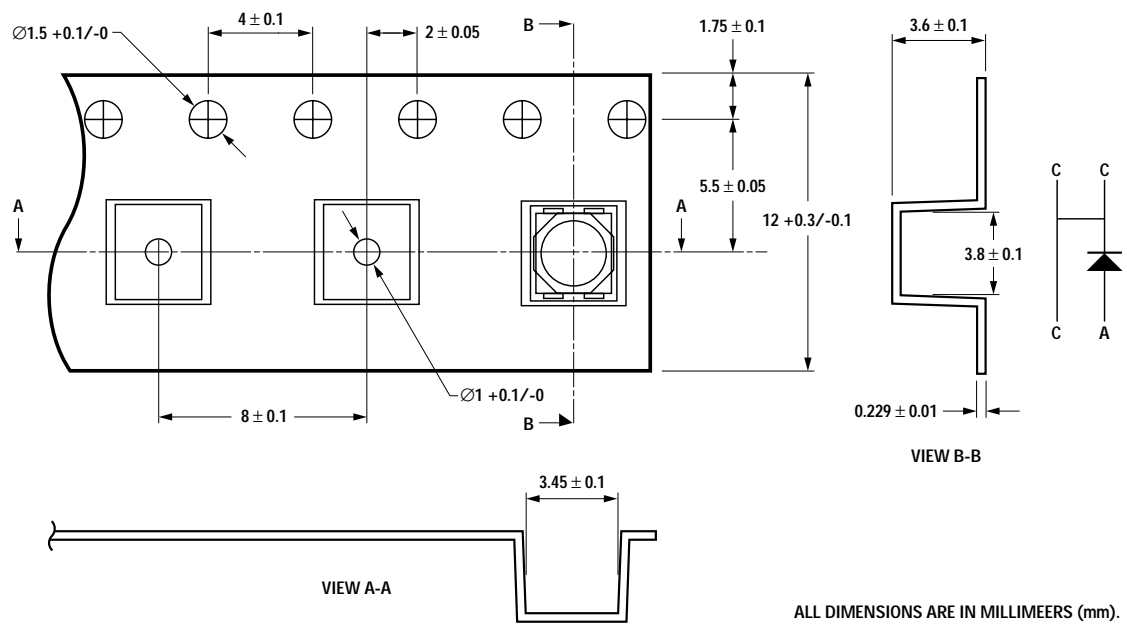

Figure 10. Tape dimensions.

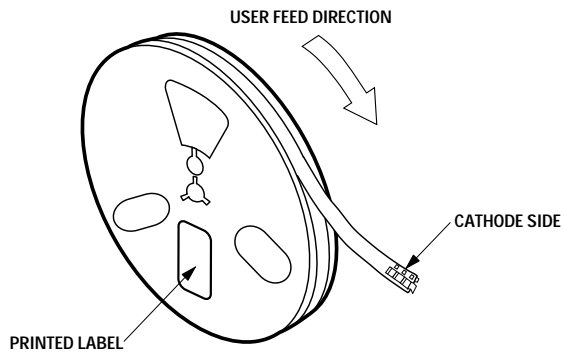

Figure 11. Reeling orientation.

**Intensity Bin Select (X<sub>2</sub>X<sub>3</sub>)**  
Individual reel will contain parts from one half bin only

X <sub>2</sub>	Min I <sub>v</sub> Bin
----------------	------------------------

**X<sub>3</sub>**

0	Full Distribution
3	3 half bins starting from X <sub>6</sub> 1
4	4 half bins starting from X <sub>6</sub> 1
5	5 half bins starting from X <sub>6</sub> 1
7	3 half bins starting from X <sub>6</sub> 2
8	4 half bins starting from X <sub>6</sub> 2
9	5 half bins starting from X <sub>6</sub> 2

**Intensity Bin Limits & Typical Flux**

Bin ID	Min. (mcd)	Max. (mcd)
V1	715.00	900.00
V2	900.00	1125.00
W1	1125.00	1400.00
W2	1400.00	1800.00
X1	1800.00	2240.00
X2	2240.00	2850.00

Tolerance of each bin limit = ±12%.

**Color Bin Select (X<sub>4</sub>)**  
Individual reel will contain parts from one full bin only.

X <sub>4</sub>	
0	Full Distribution
A	1 and 2 only
B	2 and 3 only
C	3 and 4 only
D	4 and 5 only
E	5 and 6 only
G	1, 2 and 3 only
H	2, 3 and 4 only
J	3, 4 and 5 only
K	4, 5 and 6 only
M	1, 2, 3 and 4 only
N	2, 3, 4 and 5 only
P	3, 4, 5 and 6 only
R	1, 2, 3, 4, and 5 only
S	2, 3, 4, 5 and 6 only

**Packaging Option (X<sub>5</sub>)**

Option	Test Current	Package Type	Reel Size
5	50 mA	Top Mount	7 inch

**Color Bin Limits**

Amber/ Yellow	Min. (nm)	Max. (nm)
1	582.0	584.5
2	584.5	587.0
3	587.0	589.5
4	589.5	592.0
5	592.0	594.5
6	594.5	597.0

Red Orange	Min. (nm)	Max. (nm)
1	611.0	616.0
2	616.0	620.0

Red	Min. (nm)	Max. (nm)
Full Distribution		

Tolerance of each bin limit = ± 1 nm.



**[www.agilent.com/semiconductors](http://www.agilent.com/semiconductors)**

For product information and a complete list of distributors, please go to our web site.

For technical assistance call:

Americas/Canada: +1 (800) 235-0312 or  
(916) 788-6763

Europe: +49 (0) 6441 92460

China: 10800 650 0017

Hong Kong: (+65) 6756 2394

India, Australia, New Zealand: (+65) 6755 1939

Japan: (+81 3) 3335-8152(Domestic/International), or 0120-61-1280(Domestic Only)

Korea: (+65) 6755 1989

Singapore, Malaysia, Vietnam, Thailand,  
Philippines, Indonesia: (+65) 6755 2044

Taiwan: (+65) 6755 1843

Data subject to change.

Copyright © 2005 Agilent Technologies, Inc.

January 30, 2005

5989-2308EN



**Agilent Technologies**

**LUMILEDS™**